

Canon

PUB. DIE-300

HF10 HF100

HD Camcorder

Instruction Manual



HDMI AVCHD

PAL

Important Usage Instructions

WARNING!



TO REDUCE THE RISK OF ELECTRIC SHOCK, DO NOT REMOVE COVER (OR BACK). NO USER SERVICEABLE PARTS INSIDE. REFER SERVICING TO QUALIFIED SERVICE PERSONNEL.

WARNING!



TO REDUCE THE RISK OF FIRE OR ELECTRIC SHOCK, DO NOT EXPOSE THIS PRODUCT TO RAIN OR MOISTURE.

CAUTION:

TO REDUCE THE RISK OF ELECTRIC SHOCK AND TO REDUCE ANNOYING INTERFERENCE, USE THE RECOMMENDED ACCESSORIES ONLY.

CAUTION:

DISCONNECT THE MAINS PLUG FROM THE SUPPLY SOCKET WHEN NOT IN USE.

The Mains plug is used as the disconnect device. The Mains plug shall remain readily operable to disconnect the plug in case of an accident.

While using the compact power adapter, do not wrap it or cover it with a piece of cloth, and do not place it in confined narrow spaces. Heat may build up, the plastic case may deform and it could result in electric shock or fire.

CA-570 identification plate is located on the bottom.



Using any device other than the Compact Power Adapter CA-570 may damage the camcorder.

European Union (and EEA) only.



This symbol indicates that this product is not to be disposed of with your household waste, according to the WEEE Directive (2002/96/EC) and your national law. This product should be handed over to a designated collection point, e.g., on an authorized one-for-one basis when you buy a new similar product or to an authorized collection site for recycling waste electrical and electronic equipment (EEE).

Improper handling of this type of waste could have a possible negative impact on the environment and human health due to potentially hazardous substances that are generally associated with EEE. At the same time, your cooperation in the correct disposal of this product will contribute to the effective usage of natural resources. For more information about where you can drop off your waste equipment for recycling, please contact your local city office, waste authority, approved WEEE scheme or your household waste disposal service. For more information regarding return and recycling of WEEE products, please visit www.canon-europe.com/environment. (EEA: Norway, Iceland and Liechtenstein)

Enjoying High-Definition Video with Your Camcorder

Preserve your most treasured memories, be it unforgettable scenery or cherished moments spent with family and friends, with high-definition video recordings of a quality second only to actually being there.

What is High-Definition Video?



Your camcorder features a full high-definition image sensor (Full HD CMOS) that captures video at a resolution of 1,920 x 1,080 pixels¹. This results in video recordings of unparalleled high quality, fine detail and lifelike vivid colors.

How does full high definition compare with standard-definition TV broadcasts?

5 Approximately 5 times the number of pixels.

1.9 Almost 90% more scanning lines.

"Full HD 1080" refers to Canon camcorders compliant with high-definition video composed of 1,080 vertical pixels (scanning lines).



¹ Video is recorded at this resolution only in FXP mode. In other recording modes, the picture is resized to 1,440 x 1,080 pixels before being recorded. Even in that case, the picture captured is detailed enough to render richly detailed recordings.

What is so special about recording on flash memory?

Your videos and photos are recorded in the built-in memory (**MEMO** only) or on a memory card (SD or SDHC card) using AVCHD specifications². Recording on flash memory means that there are no moving parts in the recorder unit of the camcorder. To you, it means a camcorder that is smaller, lighter and faster. In fact, using the Quick Start function (□ 34) you can open the LCD panel and start recording within approximately one second. If your high-definition TV features an SD memory card slot and supports AVCHD specifications, you can easily play back your recordings directly from the memory card (□ 36).



What is Cinema Mode?

Give your recordings a cinematic look by using the [CINE MODE] recording program (□ 42). Combine this recording program with the 25 fps progressive frame rate [**PF25** PF25] to get the enhanced effect of the 25p Cinema Mode.



² AVCHD is the new standard for recording high-definition video. With AVCHD specifications the video signal is recorded using MPEG-4 AVC/H.264 compression and the audio signal is recorded in Dolby Digital.

Table of contents

Introduction

- 4 Enjoying High-Definition Video with Your Camcorder
- 10 About this Manual
- 11 Getting to Know the Camcorder**
- 11 Supplied Accessories
- 12 Components Guide
- 15 Screen Displays

Preparations

- 18 Getting Started**
- 18 Charging the Battery Pack
- 19 Preparing the Wireless Controller and Accessories
- 22 Adjusting the Position and Brightness of the LCD Screen
- 23 Basic Operation of the Camcorder**
- 23 The **EASY** Button: **EASY** Mode or Flexible Recording
- 24 Operating Modes
- 24 Joystick and Joystick Guide
- 25 Using the Menus
- 27 First Time Settings**
- 27 Setting the Date and Time
- 28 Changing the Language
- 28 Changing the Time Zone
- 29 Using a Memory Card**
- 29 Recommended Memory Cards
- 30 Inserting and Removing a Memory Card
- 30 **HFI0** Selecting the Memory for the Recordings
- 31 Initializing the Built-In Memory (**HFI0** only) or Memory Card

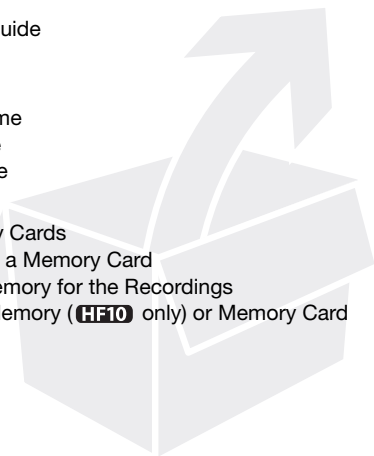

Video

- 32 Basic Recording**
- 32 Shooting Video
- 33 Selecting the Video Quality
- 34 Zooming
- 34 Quick Start Function
- 35 Reviewing and Deleting the Last Scene Recorded
- 36 Basic Playback**
- 36 Playing Back the Video
- 37 Special Playback Modes
- 38 Selecting Scenes by Recording Date
- 39 Selecting the Playback Starting Point from the Movie Timeline
- 40 Deleting Scenes
- 42 Advanced Functions**
- 42 Cinema Mode: Giving a Cinematic Look to your Recordings
- 42 Special Scene Recording Programs
- 44 Changing the Shutter Speed and Aperture
- 45 Mini Video Light
- 46 Self Timer
- 46 Automatic Backlight Correction and Manual Exposure Adjustment
- 47 Manual Focus Adjustment
- 48 White Balance
- 49 Image Effects
- 50 Digital Effects
- 51 On-Screen Displays and Data Code
- 52 Audio Recording Level
- 53 Using Headphones or an External Microphone
- 55 Managing Scenes and the Memory**
- 55 Creating a Playlist
- 56 Deleting Scenes from the Playlist
- 56 Moving Scenes in the Playlist
- 57 **HF10** Copying Scenes

Photos

58 Basic Recording

- 58 Taking Photos
- 58 Selecting Photo Size and Quality
- 60 Erasing a Photo Right After Recording It

60 Basic Playback

- 60 Viewing Photos
- 62 Magnifying Photos during Playback
- 62 Erasing Photos

63 Additional Functions

- 63 Flash
- 64 Drive Mode: Continuous Shooting and Exposure Bracketing
- 65 Capturing a Still Image while Recording Movies (Simultaneous Recording)
- 66 Light Metering Mode
- 66 Histogram Display
- 67 Capturing a Still Image from the Playback Scene
- 67 Protecting Photos
- 68 **HiFi** Copying Photos
- 69 Other Functions You Can Use when Taking Photos

69 Printing Photos

- 69 Printing Photos (Direct Print)
- 70 Selecting the Print Settings
- 73 Trimming Settings
- 73 Print Orders

External Connections

75 Terminals on the Camcorder

- 77 Connection Diagrams
- 79 Playback on a TV Screen

80 Saving and Backing Up Your Recordings

- 80 Backing Up Your Recordings on a Computer

80	Authoring High-Definition (AVCHD) Discs and Photo DVDs
83	Copying your Recordings to an External Video Recorder
84	Transferring Photos to a Computer (Direct Transfer)
86	Transfer Orders

Additional Information

88 Appendix: Menu Options Lists

88	FUNC. Menu
90	Setup Menus
90	Camera Setup (Digital Zoom, Image Stabilizer, etc.)
92	Memory Operations (Initialization, etc.)
93	Display Setup (LCD Brightness, Language, etc.)
94	System Setup (Speaker Volume, Beep, etc.)
96	Date/Time Setup

97 Trouble?

97	Troubleshooting
101	List of Messages

109 Do's and Don'ts

109	Handling Precautions
112	Maintenance/Others
113	Using the Camcorder Abroad

114 General Information

114	System Diagram
115	Optional Accessories
119	Specifications
122	Index

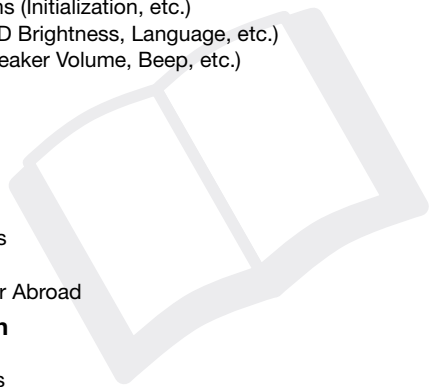

About this Manual

Thank you for purchasing the Canon HF10/HF100. Please read this manual carefully before you use the camcorder and retain it for future reference. Should your camcorder fail to operate correctly, refer to *Troubleshooting* (□ 97).

Conventions Used in this Manual

- **!** IMPORTANT: Precautions related to the camcorder's operation.
- **i** NOTES: Additional topics that complement the basic operating procedures.
- **⚠** POINTS TO CHECK: Restrictions or requirements regarding the function described.
- **□**: Reference page number within this manual.

To complete some operations you will need to refer also to other instruction manuals. This will be indicated with the following icons and the name of the relevant chapter or section.

DVSD > Refer to the "Digital Video Software" instruction manual, included as a PDF file in the supplied **DIGITAL VIDEO Solution Disk** CD-ROM.

DW-100 > Refer to the instruction manual of the optional DW-100 DVD Burner.

- **HF10** : Text that applies only to the model(s) shown in the icon.
- The following terms are used in this manual:
When not specified as "memory card" or "built-in memory", the term "memory" by itself refers to both (**HF10** only).
"Scene" refers to one movie unit from the point you press the START/STOP button to start recording until you press again to pause the recording.
"Photo" and "still image" are used interchangeably with the same meaning.
- The photos included in this manual are simulated pictures taken with a still camera. Unless indicated otherwise, illustrations and menu icons refer to the **HF10**.





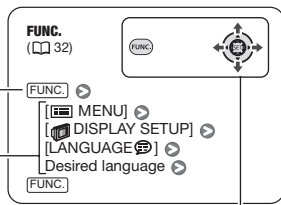

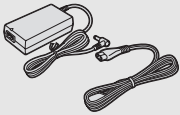

Names of buttons and switches other than the joystick are indicated within a "button" frame. For example **[FUNC.]**.

Brackets [] and capital letters are used to refer to menu options as they are displayed on screen. In tables in this manual the default value is shown in boldface. For example **[ON]**, [OFF].

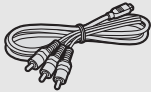
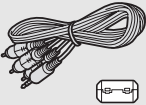
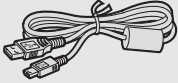

Buttons and switches to be operated

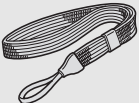
Supplied Accessories

	<p>CA-570 Compact Power Adapter (incl. power cord)</p>		<p>BP-809 Battery Pack</p>
<p>WL-D88 Wireless Controller</p>		<p>Lithium Button Battery CR2025 for Wireless Controller</p>	
	<p>CTC-100/S Component Cable Red • Green • Blue plugs</p>		<p>STV-250N Stereo Video Cable Yellow • Red • White plugs (incl. ferrite core)</p>
<p>IFC-400PCU USB Cable</p>		<p>Software CD-ROM¹ and Installation Guide PIXELA ImageMixer 3 SE</p>	
	<p>WS-30 Wrist Strap</p>		<p>Software CD-ROM² DIGITAL VIDEO Solution Disk</p>

¹ Software for saving, managing, editing and playing back movies on your computer (□□ 80). The CD-ROM includes the instruction manual of the software (electronic version on PDF file).

² Software for saving, managing, retouching and printing photos (□□ 84). The CD-ROM includes the instruction manual of the software (electronic version on PDF file).

Components Guide

Left side view

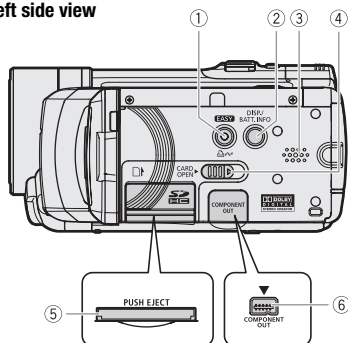

- ① **EASY** button (□ 23)/
 (print/share) button (□ 70, 84)
- ② **DISP.** (on-screen display) button
 (□ 51, 39)/
BATT. INFO button (□ 17)
- ③ **Speaker** (□ 38)
- ④ **CARD OPEN** switch (open the memory
 card slot cover) (□ 30)
- ⑤ **Memory card slot** (□ 30)
- ⑥ **COMPONENT OUT** terminal (□ 77)
- ⑦ **Mode dial** (□ 24)
- ⑧ **HDMI OUT** mini terminal (□ 77, 79)
- ⑨ **USB** terminal (□ 78)
- ⑩ **Instant AF sensor** (□ 90)
- ⑪ **Flash** (□ 63)
- ⑫ **Stereo microphone**
- ⑬ **Mini video light** (□ 45)

Right side view

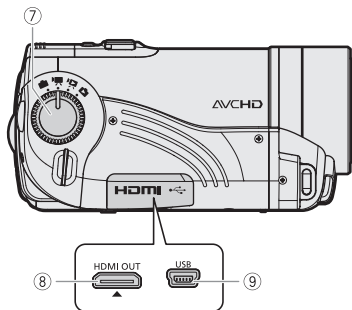

Names of buttons and switches other than the joystick are indicated within a “button” frame (for example **[FUNC.]**).

Front view

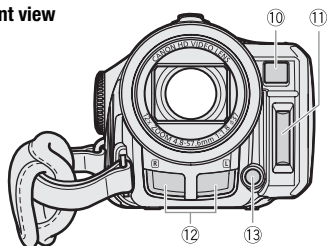

Back view

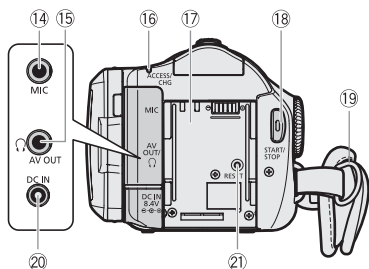

LCD panel

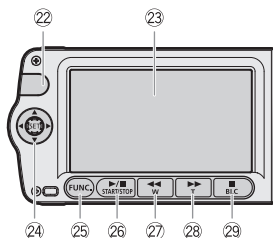

Top view

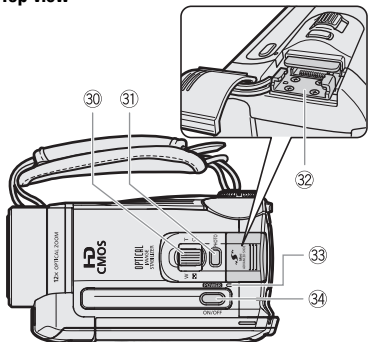

- 14 MIC terminal (54)
- 15 AV OUT/⌚ terminal (77)
- 16 ACCESS (memory access) indicator (32, 58)/CHG (charge) indicator (18)
- 17 Serial number
- 18 START/STOP button (32)
- 19 Strap mount (20)
- 20 DC IN terminal (18)
- 21 RESET button (99)
- 22 Remote sensor (20)
- 23 LCD screen (22)
- 24 Joystick (24)
- 25 FUNC. button (25, 88)
- 26 ►/⏸ (play/pause) button (36)/ START/STOP button (32)
- 27 ◀◀ (fast reverse) button (36)/ Zoom out **W** (wide-angle) button (34)
- 28 ▶▶ (fast forward) button (36)/ Zoom in **T** (telephoto) button (34)
- 29 ■ (stop) button (36)/ BLC (backlight correction) button (46)
- 30 Zoom lever (34)
- 31 PHOTO button (58)
- 32 Mini advanced shoe (54)
- 33 **POWER** indicator
- 34 ON/OFF button

Names of buttons and switches other than the joystick are indicated within a “button” frame (for example **FUNC.**).

Bottom view

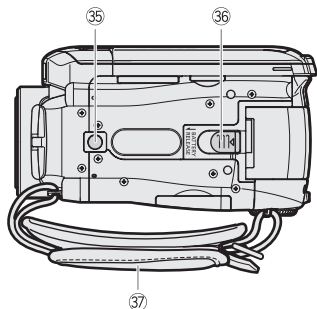

- 35 Tripod socket (□ 109)
- 36 BATTERY RELEASE switch (□ 19)
- 37 Grip belt

Wireless Controller WL-D88

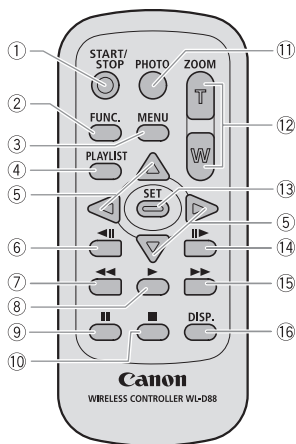

- ① START/STOP button (□ 32)
- ② FUNC. button (□ 25, 88)
- ③ MENU button (□ 26, 90)
- ④ PLAYLIST button (□ 36)
- ⑤ Navigation buttons (▲/▼/◀/▶)
- ⑥ ◀|| (frame reverse) button (□ 37)
- ⑦ ◀◀ (fast reverse) button (□ 37)
- ⑧ ▶ (play) button (□ 36)
- ⑨ || (pause) button (□ 36)
- ⑩ ■ (stop) button (□ 36)
- ⑪ PHOTO button (□ 58)
- ⑫ Zoom buttons (□ 34)
- ⑬ SET button
- ⑭ ||▶ (frame advance) button (□ 37)
- ⑮ ▶▶ (fast forward) button (□ 37)
- ⑯ DISP. (on-screen display) button (□ 39, 51)

Screen Displays

Recording Movies

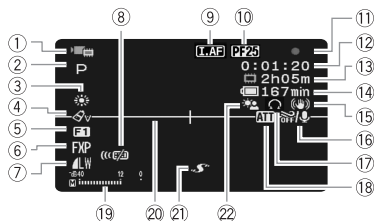

Playing Movies (During Playback)





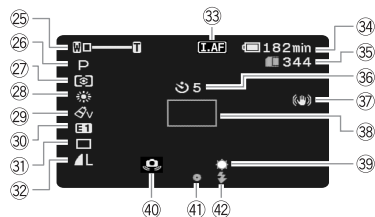

- ① Operating mode (24)
- ② Recording program (42, 43)
- ③ White balance (48)
- ④ Image effect (49)
- ⑤ Digital effects (50)
- ⑥ Recording mode (33)
- ⑦ Still image quality/size (simultaneous recording) (65)
- ⑧ Remote sensor off (95)
- ⑨ **IAF** Instant AF (90), MF Manual focus (47)
- ⑩ 25F progressive frame rate (17)
- ⑪ Memory operation (17)
- ⑫ Time code/Playback time (hours : minutes : seconds)
- ⑬ Remaining recording time
 - On the memory card
 - HF10** () In the built-in memory
- ⑭ Remaining battery time (17)
- ⑮ Image stabilizer (91)
- ⑯ Wind screen off (92)
- ⑰ Headphones output (53)
- ⑱ Microphone attenuator (52)
- ⑲ Audio level indicator (52)
- ⑳ Level marker (93)
- ㉑ Mini advanced shoe (54)
- ㉒ Backlight correction (46)
- ㉓ Scene number
- ㉔ Data code (51)

Recording Still Images

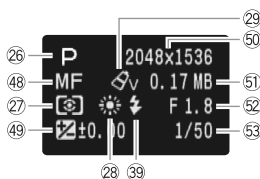
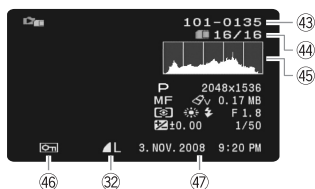



Viewing Still Images



- 25 Zoom (□ 34), Exposure  (□ 46)
- 26 Recording program (□ 42, 43)
- 27 Light metering mode (□ 66)
- 28 White balance (□ 48)
- 29 Image effect (□ 49)
- 30 Digital effects (□ 50)
- 31 Drive mode (□ 64)
- 32 Still image quality/size (□ 58)
- 33 I.A.F. Instant AF (□ 90), MF Manual focus (□ 47)
- 34 Remaining battery time (□ 17)
- 35 Number of still images available
 -  On the memory card
 -  In the built-in memory
- 36 Self timer (□ 46)
- 37 Image stabilizer (□ 91)
- 38 AF frame (□ 91)
- 39 Mini video light (□ 45)
- 40 Camcorder shake warning (□ 91)
- 41 Focus and exposure lock (□ 58)
- 42 Flash (□ 63)
- 43 Image number (□ 95)
- 44 Current image / Total number of images
- 45 Histogram (□ 66)
- 46 Image protection mark (□ 67)
- 47 Date and time of recording
- 48 Manual focus (□ 47)
- 49 Manual exposure (□ 46)
- 50 Image size (□ 58)
- 51 File size
- 52 Aperture value (□ 43)
- 53 Shutter speed (□ 43)



10 25F progressive frame rate

Select the 25F progressive frame rate ( 42) to give your recordings a cinematic look. You can combine this frame rate with the [ CINE MODE] recording program to enhance the effect.

11 Memory operation

- Record, ● ||| Record pause,
- ▶ Playback, ||| Playback pause,
- ▶▶ Fast playback,
- ◀◀ Fast reverse playback,
- ▶ Slow playback,
- ◀ Slow reverse playback,
- ||▶ Frame advance,
- ◀|| Frame reverse

13 Remaining recording time

When there is no more free space on the memory, “ END” (built-in memory, **HFi10** only) or “ END” (memory card) will be displayed and the recording will stop.



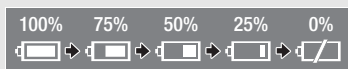

14, 34 Remaining battery time



- The icon shows a rough estimate of the remaining charge as a percentage of the full charge of the battery pack. The remaining recording/playback time of the battery pack is displayed, in minutes, next to the icon.
- When  is displayed in red, replace the battery pack with a fully charged one.

- When you attach an empty battery pack, the power may turn off without displaying .
- Depending on the conditions under which the camcorder and the battery pack are used, the actual battery charge may not be indicated accurately.
- When the camcorder is off, press **[BATT.INFO]** to display the charge status of a battery pack. The Intelligent System will display the charge status (as a percentage) and the remaining recording time (in minutes) for 5 seconds. If the battery pack is exhausted, the battery information may not be displayed.

35 Number of still images available

-  in red: No card
-  in green: 6 or more images
-  in yellow: 1 to 5 images
-  in red: No more images can be recorded
- When viewing the still images, the display will always be in green.
- Depending on the recording conditions, the number of available still images displayed may not decrease even after a recording has been made, or may decrease by 2 still images at once.

43 Image number

The image number indicates the name and location of the file on the memory card. For example, the file name of image 101-0107 is “IMG_0107.JPG”, stored under the folder “DCIM\101\CANON”.



Preparations

This chapter describes basic operations, such as navigating the menus, and first time settings to help you learn more about your camcorder.

Getting Started

Charging the Battery Pack

The camcorder can be powered with a battery pack or directly using the compact power adapter. Charge the battery pack before use.

For approximate charging times and recording/playback times with a full battery pack, refer to the tables on pages 115-116.

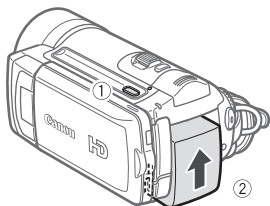

1 Turn off the camcorder.

2 Attach the battery pack to the camcorder.

Press the battery pack softly into the battery attachment unit and slide it up until it clicks in place.

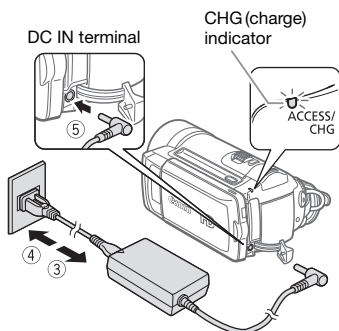

3 Connect the power cord to the compact power adapter.

4 Plug the power cord into a power outlet.

5 Connect the compact power adapter to the camcorder's DC IN terminal.

- The CHG (charge) indicator starts flashing. The indicator will stay on when the charging is completed.
- If the indicator flashes quickly, refer to *Troubleshooting* (□ 97).

ONCE THE BATTERY PACK IS FULLY CHARGED

1 Disconnect the compact power adapter from the camcorder.

2 Unplug the power cord from the power outlet and the compact power adapter.



TO REMOVE THE BATTERY PACK

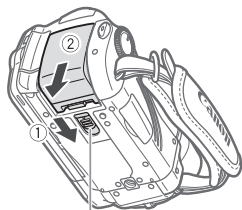

BATTERY RELEASE
switch

- 1 Slide **BATTERY RELEASE** in the direction of the arrow and hold it pressed down.
- 2 Slide the battery pack down and then pull it out.

! IMPORTANT

- Turn off the camcorder before connecting or disconnecting the compact power adapter. After pressing **ON/OFF** to turn off the camcorder, important data is updated in the memory. Be sure to wait until the **POWER** indicator turns off.
- We recommend charging the battery pack in temperatures between 10 °C and 30 °C. Outside the temperature range of 0 °C to 40 °C, the charging will not start.
- Do not connect to the camcorder's DC IN terminal or to the compact power adapter any electrical equipment that is not expressly recommended for use with this camcorder.
- To prevent equipment breakdowns and excessive heating, do not connect the supplied compact power adapter to

voltage converters for overseas travels or special power sources such as those on aircraft and ships, DC-AC inverters, etc.

i NOTES

- If remaining battery time is an issue, you can power the camcorder using the compact power adapter so the battery pack will not be consumed.
- Charged battery packs continue to discharge naturally. Therefore, charge them on the day of use, or the day before, to ensure a full charge.
- We recommend that you prepare battery packs to last 2 to 3 times longer than you think you might need.

Preparing the Wireless Controller and Accessories

First, insert the supplied lithium button battery CR2025 into the wireless controller.

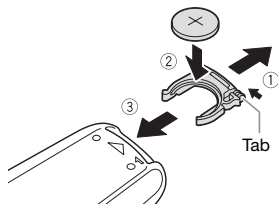

- 1 Press the tab in the direction of the arrow and pull out the battery holder.
- 2 Place the lithium button battery with the + side facing up.
- 3 Insert the battery holder.

TO USE THE WIRELESS CONTROLLER

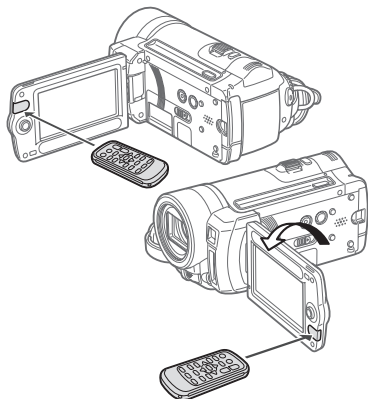

Point the wireless controller at the camcorder's remote sensor when you press the buttons.

You can rotate the LCD panel 180 degrees to use the wireless controller from the front of the camcorder.

i NOTES

- The wireless controller may not work properly when the remote sensor is situated under strong light sources or direct sunlight.
- If the wireless controller does not work, check that [WL.REMOTE] is not set to [OFF OFF] (95). Otherwise, replace the battery.

Accessories

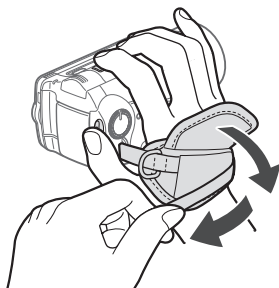

Fasten the grip belt.

- Adjust the grip belt so that you can reach the zoom lever with your index finger, and the [START/STOP] button with your thumb.
- You can remove the grip belt and replace it with the supplied wrist strap.

TO REMOVE THE GRIP BELT

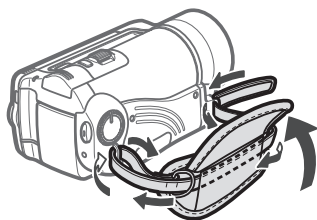

- 1 **Lift the padded handgrip's flap and detach the strap from the Velcro pad.**

- 2 Pull the strap to remove it first from the front bracket on the camcorder, then to unthread it from the handgrip and finally to remove it from the rear bracket on the camcorder.

TO ATTACH A WRIST STRAP

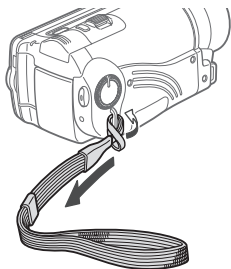

Pass the attaching end of the wrist strap through the back bracket on the camcorder, thread the wrist strap through the loop and fasten.

You can also attach the wrist strap to the strap mount on the grip belt to use both for extra convenience and protection.

TO ATTACH A SHOULDER STRAP

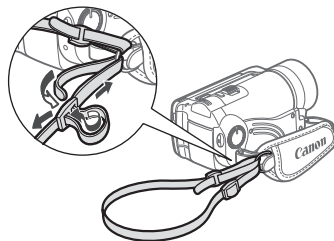

Pass the ends of the shoulder strap through the strap mount on the grip belt and adjust the length of the strap.

You can also remove the grip belt and attach the shoulder strap directly to the rear bracket on the camcorder.

TO REATTACH THE GRIP BELT

- 1 Pass the end of the strap through the rear bracket on the camcorder.
- 2 Thread the strap through the padded handgrip and then pass it through the front bracket on the camcorder.
- 3 Fasten the grip belt as necessary, attach the strap to the Velcro pad on the handgrip and close the flap.

Adjusting the Position and Brightness of the LCD Screen

Rotating the LCD Panel

Open the LCD panel 90 degrees.

- You can rotate the panel 90 degrees downward.
- You can rotate the panel 180 degrees toward the lens. Rotating the LCD panel 180 degrees can be useful in the following cases:
 - When you wish to include yourself in the picture when recording with the self timer.
 - To allow the camcorder to be operated with the wireless controller from the front.

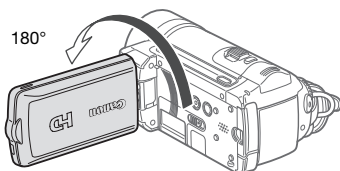
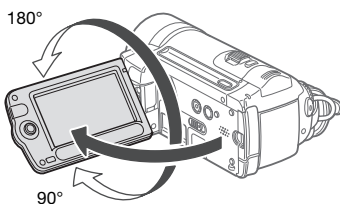

Subject can monitor the LCD screen

i NOTES

About the LCD screen: The screen is produced using extremely high-precision manufacturing techniques, with more than 99.99% of the pixels operating to specification. Less than 0.01% of the pixels may occasionally misfire or appear as black, red, blue or green dots. This has no effect on the recorded image and does not constitute a malfunction.

LCD Backlight

You can set the brightness of the screen to normal or bright.

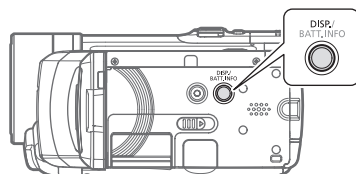

Hold **DISP.** pressed down for more than 2 seconds.

Repeat this action to toggle between the normal and bright settings.

i NOTES

- This setting does not affect the brightness of the recording.
- Using the bright setting will shorten the effective usage time of the battery pack.



Basic Operation of the Camcorder

The **EASY** Button: **EASY** Mode or Flexible Recording

The camcorder offers two basic modes for recording video or still images: **EASY** mode for beginners or if you just prefer not to bother with detailed camcorder settings, and **flexible recording** mode which lets you change the camcorder's settings to your preference.

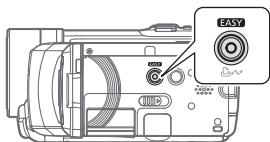

Press the **EASY** button to enter the **EASY** mode (the button's blue light will be on). You do not need to worry about any settings and can shoot video using just the zoom lever (□ 34) and **[START/STOP]** (□ 32) or take photos using just the zoom lever and **[PHOTO]** (□ 58).



Press the **EASY** button again to return to the flexible recording mode (the button's light is off). You can access the menus and change settings to your preference. Even in flexible recording



mode, the camcorder can help you with the settings. For example, you can use the Special Scene recording programs (□ 42) to set at once all the optimal settings to match special recording conditions.

i NOTES

In **EASY** mode you cannot access the menus but you can change the following settings in advance, before setting the camcorder to **EASY** mode.





- Recording mode of movies
- Size/quality of still images
- Auto slow shutter
- All settings in the [SYSTEM SETUP] menu

Operating Modes



The camcorder's operating mode is determined by the position of the mode dial. In this manual,  indicates that a function is available in the operating mode shown and  indicates that the function is not available. When no operating mode icons are given, the function is available in all operating modes.

Joystick and Joystick Guide













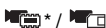

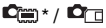

Use the joystick to operate the camcorder's menus.

Push the joystick up, down, left or right (, , , ) to select an item or change settings.

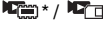

Press the joystick itself () to save the settings or confirm an action. On menu screens, this is indicated by the icon .

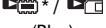
The joystick can also be used in combination with the joystick guide to operate additional functions. Press  to display/hide the joystick guide. The functions that appear on the joystick guide will change depending on the operating mode. In the illustrations of this manual, positions other than those relevant to the function explained are marked with a striped pattern.

Operating mode	Mode dial	Icon display	Operation	
		 * /  (Green)	Recording movies in the built-in memory* / on the memory card	32
		 * /  (Blue)	Recording still images in the built-in memory* / on the memory card	58
		 * /  (Green)	Playing movies from the built-in memory* / memory card	36
		 * /  (Blue)	Viewing still images from the built-in memory* / memory card	60

* **HF10** only.



Depending on the operating mode, these positions may be empty or show a different icon than the one on the illustration.



When the guide contains multiple "pages", [NEXT] and the page number icon (▼) will appear at the bottom position. Push the joystick (▼) toward [NEXT] to display the next "page" of the guide.

Using the Menus

Many of the camcorder's functions can be adjusted from the menus that open after pressing the FUNC. button (FUNC.). To access the menus set the camcorder to flexible recording mode. In EASY mode, except for a few exceptions, most menu settings will return to their default values (□ 23). For details about the available menu options and settings, refer to the appendix *Menu Options Lists* (□ 88).

Selecting a FUNC. Menu Option

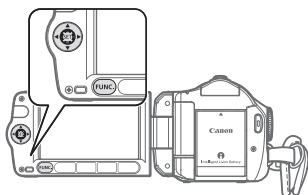

- 1 Press **FUNC.**
- 2 Select (▲▼) the icon of the function you want to change from the left side column.
Menu items not available will appear grayed out.
- 3 Select (◀▶) the desired setting from the available options at the bottom bar.
 - The selected option will be highlighted in orange.
 - With some settings you will need to make further selections and/or press **SET**. Follow the additional operation guides that will appear on the screen (such as the **SET** icon, small arrows, etc.).
- 4 Press **FUNC.** to save the settings and close the menu.

You can press **FUNC.** to close the menu at any time.

Selecting an Option from the Setup Menus

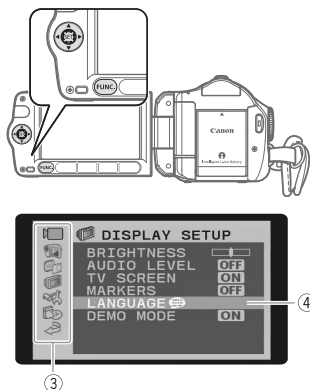

- 1 Press **[FUNC.]**.
- 2 Select (**▲▼**) the **[MENU]** icon and press **[SET]** to open the setup menus.
You can also hold **[FUNC.]** pressed down for more than 1 second or press **[MENU]** on the wireless controller to open directly the setup menu screen.
- 3 Select (**▲▼**) the desired menu from the left side column and press **[SET]**.
The title of the selected menu appears on top of the screen and under it the list of settings.
- 4 Select (**▲▼**) the setting you want to change and press **[SET]**.
 - The orange selection bar indicates the menu setting currently selected. Items not available appear in black.
 - Push the joystick (**◀**) to return to the menu selection screen (step 3).
- 5 Select (**▲▼**) the desired option and press **[SET]** to save the setting.

- 6 Press **[FUNC.]**.

You can press **[FUNC.]** to close the menu at any time.

Abbreviation of Menu Selections in this Manual

In this manual, the **[▶]** arrow is used to abbreviate menu selections. Below is an example of changing a setting using the setup menus.

[FUNC.] **[▶]**
[MENU] **[▶]**
[DISPLAY SETUP] **[▶]**
[LANGUAGE] **[▶]**
 Desired language **[▶]**
[FUNC.]

For selections in the **[FUNC.]** menu, the abbreviated form will always show the initial default value. In recording mode, its icon will appear on the left side column when you first open the menu. If the setting was changed, the icon of the currently selected option will appear instead.

[FUNC.] **[▶]**
[OFF IMAGE EFFECT OFF] **[▶]**
 Desired image effect **[▶]**
[FUNC.]

First Time Settings

Setting the Date and Time

You will need to set the date and time of the camcorder before you can start using it. The [DATE/TIME] screen will appear automatically when the camcorder's clock is not set.



When the [DATE/TIME] screen appears, the year will be displayed in orange and indicated with up/down arrows.

- 1 Change (▲▼) the year and move (▶) to the month.
- 2 Change the rest of the fields (month, day, hour and minutes) in the same way.
- 3 Select (▶) [OK] and press (SET) to start the clock and close the setup screen.

! IMPORTANT

- When you do not use the camcorder for about 3 months, the built-in rechargeable lithium battery may discharge completely and the date and time setting may be lost. In such case, recharge the built-in lithium battery (☐ 111) and set the time zone, date and time again.
- The date appears in a year-month-day format only in the first setup screen. In subsequent screen displays the date and time will appear as day-month-year (for example, [1.JAN.2008 12:00 AM]). You can change the date format (☐ 96).
- You can also change the date and time later on (not during the initial setup). To open the [DATE/TIME] screen:

[FUNC.] (◀) [MENU] (▶)
 [DATE/TIME SETUP] (▶)
 [DATE/TIME]

Changing the Language

Options

◆ Default value

[ČEŠTINA]	[MAGYAR]	[العربية]
[DEUTSCH]	[MELAYU]	[فارسی]
[ΕΛΛΗΝΙΚΑ]	[POLSKI]	[ภาษาไทย]
[ENGLISH]◆	[ROMÂNĂ]	[简体中文]
[ESPAÑOL]	[TÜRKÇE]	[繁體中文]
[FRANÇAIS]	[РУССКИЙ]	[한국어]
[ITALIANO]	[УКРАЇНСЬКА]	[日本語]

FUNC.
(26)

FUNC.



FUNC. >

[MENU] >

[DISPLAY SETUP] >

[LANGUAGE] >

Desired language >

FUNC.

NOTES

- If you changed the language by mistake, follow the mark next to the menu item to change the setting.
- The displays **SET** and **FUNC** that appear in some menu screens refer to the name of buttons on the camcorder and will not change, regardless of the language selected.

Changing the Time Zone

Change the time zone to match your location. The default setting is Paris.

FUNC.

(26)

FUNC.



TO SET THE HOME TIME ZONE

FUNC. >

[MENU] >

[DATE/TIME SETUP] >

[T.ZONE/DST] > >

Your local time zone* >

FUNC.

WHEN YOU TRAVEL

FUNC. >

[MENU] >

[DATE/TIME SETUP] >

[T.ZONE/DST] > >

Local time at your destination* >

FUNC.

* To adjust for daylight saving time, select the area name marked with a .

Using a Memory Card

Recommended Memory Cards

You can use commercially available SDHC (SD high capacity) memory cards and SD memory cards with this camcorder. However, depending on its Speed Class, you may not be able to record movies on the memory card. Refer to the table below.

As of January 2008, the movie recording function has been tested using SD/SDHC memory cards made by Panasonic, SanDisk and Toshiba. We recommend using memory cards with a Speed Class 4 or higher.

NOTES

- About SDHC Memory Cards:** SDHC is the new type of SD memory card with capacities over 2 GB. Please note that the specifications of SDHC memory cards are different from those of regular SD memory cards and you will not be able to use memory cards of over 2 GB with devices that do not support SDHC. However, SDHC devices (including this camcorder) are backward compatible and support regular SD memory cards.
- About the SD Speed Class:** The SD Speed Class is a standard that indicates the minimum guaranteed data transfer speed of SD/SDHC memory cards. When you buy a new memory card, look for the Speed Class logo on the package.

Memory card	Capacity	SD Speed Class	Recording movies	Recording still images
SD memory cards	64 MB or less	Not applicable	—	●
	128 MB or more	Not compatible	● ^{1,2}	
		CLASS or higher	● ¹	
SDHC memory cards	Over 2 GB	CLASS or higher	●	
		CLASS or higher	● ¹	

¹ Except for the [HIGH QUALITY 17 Mbps] recording mode.

² On some memory cards you may not be able to record movies.

Inserting and Removing a Memory Card

Make sure to initialize all memory cards before using them with this camcorder (p 31).

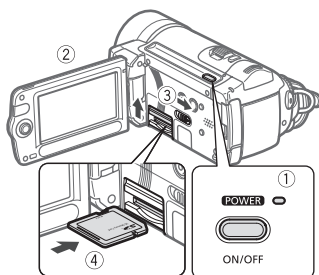

- 1 Turn off the camcorder.
- 2 Open the LCD panel.
- 3 Slide **CARD OPEN** toward the right to open the memory card slot cover.
- 4 Insert the memory card straight, with the label facing up, all the way into the memory card slot until it clicks.
- 5 Close the memory card slot cover.
 - Pull the cover down until it clicks.
 - Do not force the cover closed if the memory card is not correctly inserted.

TO REMOVE THE MEMORY CARD

- 1 Slide **CARD OPEN** toward the right to open the memory card slot cover.

- 2 Push the memory card once to release it. When the memory card springs out, pull it all the way out.
- 3 Close the memory card slot cover.

! IMPORTANT

Memory cards have front and back sides that are not interchangeable. Inserting a memory card facing the wrong direction can cause a malfunction of the camcorder.

MEM Selecting the Memory for the Recordings

You can select to record your movies and still images in the built-in memory or on the memory card. The built-in memory is the default media for recording both.



FUNC.
(p 26)

FUNC.



TO CHANGE THE MEDIA FOR RECORDING MOVIES

- FUNC.** >
- [MENU] >
 - [MEMORY OPER.] >
 - [MEDIA:MOVIES]* >
 - The memory you want to use >
- FUNC.**

* Select [MEDIA:IMAGES] to change the media to be used for recording still images.



i NOTES

When selecting the memory for the recordings, information about the memory currently selected (total capacity, amount of memory in use, and available space) will be displayed on the screen. Estimated figures about available movie recording time and available number of still images are approximate and based on the recording mode and still image quality/size settings currently in use.

Initializing the Built-In Memory (HF10 only) or Memory Card

Initialize memory cards when you use them with this camcorder for the first time. You can also initialize a memory card or the built-in memory (**HF10** only) to permanently delete all the recordings it contains. Initializing the memory also eliminates memory fragmentation. Fragmentation becomes more serious as recordings are repeatedly added and deleted and can eventually result in reduced performance.

Options

[INITIALIZE]
Clears the file allocation table but does not physically erase the stored data.
[COMPL.INIT.]
Erases all data completely.

FUNC.
(26)



HF10

FUNC.

[MENU]

[MEMORY OPER.]

[INITIALIZE] The memory you want to initialize

Initialization method

[YES]* [OK]

FUNC.

HF100

FUNC.

[MENU]

[MEMORY OPER.]

[INITIALIZE]

Initialization method

[YES]* [OK]

FUNC.

* Press to cancel the complete initialization while it is in progress. All recordings will be erased and the memory can be used without any problem.

! IMPORTANT

- Initializing the memory will permanently erase all recordings. The lost original recordings cannot be recovered. Make sure you back up important recordings in advance using an external device (80).
- While the initialization is in progress, do not disconnect the power source or turn off the camcorder.



Video

This chapter covers functions related to shooting movies, including recording, playback, menu options, and memory operations.

Basic Recording

Shooting Video

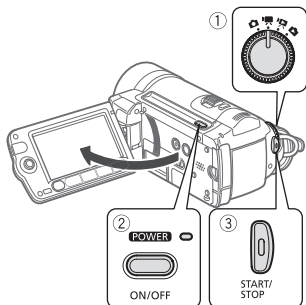



1 Set the mode dial to .

2 Turn on the camcorder.

HF10 You can select the memory to be used for recording movies (□ 30).

3 Press  to begin recording.

- Recording starts; press  again to pause the recording.
- You can also press  on the LCD panel.

WHEN YOU HAVE FINISHED RECORDING

- 1 Make sure that the ACCESS indicator is off.**
- 2 Turn off the camcorder.**
- 3 Close the LCD panel.**

IMPORTANT

Observe the following precautions while the ACCESS indicator is on or flashing. Failing to do so may result in permanent data loss or damage to the memory.

- Do not open the memory card slot cover.
- Do not disconnect the power source or turn off the camcorder.
- Do not change the position of the mode dial.

NOTES

- **About the Power Save mode:** To save power when the camcorder is powered by a battery pack, the camcorder will automatically shut off if left without any operations for 5 minutes (□ 95). Press  to turn on the camcorder.
- When recording in bright places it may be difficult to use the LCD screen. In such case, change the brightness of the LCD screen (□ 22, 93).

Selecting the Video Quality (Recording Mode)

The camcorder offers 4 recording modes. Changing the recording mode will change the recording time available on the memory. Select FXP or XP+ mode for better movie quality; select LP mode for longer recording times. The table below gives approximate recording times.



FUNC.

(25)

FUNC.



FUNC.

[**SP** STANDARD PLAY 7 Mbps]

Desired recording mode

FUNC.

NOTES

- The camcorder uses a variable bit rate (VBR) to encode video so the actual recording times will vary depending on the content of the scenes.
- The camcorder retains the last setting used even if you set the camcorder to **EASY** mode.

Approximate recording times

Default value

Recording mode	FXP*	XP+	SP [◆]	LP
Memory				
HF10 Built-in memory	2 hr. 5 min.	2 hr. 50 min.	4 hr. 45 min.	6 hr. 5 min.
2 GB memory card	15 min.	20 min.	35 min.	45 min.
4 GB memory card	30 min.	40 min.	1 hr. 10 min.	1 hr. 30 min.
8 GB memory card	1 hr.	1 hr. 25 min.	2 hr. 20 min.	3 hr.

* Recorded in 1,920 x 1,080 resolution. Movies recorded using other recording modes are recorded in 1,440 x 1,080 resolution.

Zooming



mode: In addition to the optical zoom, digital zoom is also available (p 90).

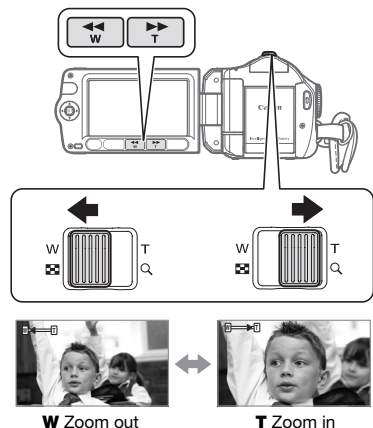

12x Optical Zoom

Move the zoom lever toward **W to zoom out (wide angle). Move it toward **T** to zoom in (telephoto).**

Press gently for a slow zoom; press harder for faster zooms. You can also set [ZOOM SPEED] (p 90) to one of three constant speeds (3 is the fastest, 1 the slowest).

i NOTES

- Keep at least 1 m away from the subject. At full wide angle, you can focus on a subject as close as 1 cm.
- When [ZOOM SPEED] is set to [VAR VARIABLE]:
 - When you use the **T** and **W** buttons on the wireless controller or LCD panel, the zoom speed will be constant at [SPEED 3].
 - The zoom speed will be faster in record pause mode than when actually recording.

Quick Start Function

When you close the LCD panel with the camcorder on, the camcorder enters the standby mode. In standby mode the camcorder consumes only about half the power used when recording, saving energy when you are using a battery pack. Additionally, when you open the LCD panel, the camcorder is ready to start recording in approximately 1 second, ensuring you do not miss important shooting opportunities.



1 With the camcorder on and in a recording mode, close the LCD panel.

A beep will sound and the **POWER** indicator will change to orange to indicate the camcorder entered the standby mode.



2 When you wish to resume recording, open the LCD panel.

Within less than 1 second, the **POWER** indicator will return to green and the camcorder will be ready to record.

! IMPORTANT

Do not disconnect the power source during standby mode (while the **POWER** indicator is lit in orange).

i NOTES

- If you close the LCD panel under some circumstances (for example while recording, while a menu is being displayed, or while the memory card slot is open), the camcorder may not enter the standby mode. Check that the **POWER** indicator changes to orange.
- The camcorder will shut off if left in standby mode for 10 minutes, regardless of the [POWER SAVE] setting (□ 95). Press **[ON/OFF]** to turn on the camcorder.
- You can select the length of time until shut-off or turn off the Quick Start function with the [QUICK START] setting (□ 95).

Reviewing and Deleting the Last Scene Recorded

Even in  mode you can play back the last scene recorded in order to check it. You can also delete the scene while reviewing it.



1 If the joystick guide does not appear on screen, press **[SET]** to display it.

If  does not appear on the joystick guide, repeatedly push the joystick (**▼**) toward [NEXT] to display it.

2 Push the joystick (**◀**) toward .

The camcorder plays back the last scene (but without sound) and returns to record pause mode.

Deleting a Scene After Recording It

After recording a scene:

1 Review the scene as described in the previous section.

2 While reviewing the scene, select **(▶)** the icon and press **[SET]**.

3 Select **(▶)** [YES] and press **[SET]**.

i NOTES

- Avoid any other operations on the camcorder while the scene is being deleted.
- You will not be able to delete the last scene if after the scene was recorded you changed the operating mode or turned the camcorder off.

Basic Playback

Playing Back the Video



(24)

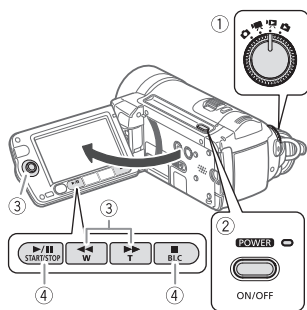

1 Set the mode dial to .

2 Turn on the camcorder.

The scene index screen appears after a few seconds.

3 Move (,) the selection frame to the scene you want to play back.

When you have recorded a large number of scenes, press or to move between index screen pages.

4 Press or to begin the playback.

- Playback will start from the scene selected and continue until the end of the last scene recorded.
- Press again to pause the playback.

- Press to stop the playback and return to the scene index screen.

TO SELECT WHICH SCENES TO PLAY BACK

After creating a playlist (55), you can switch between the original movies and the playlist you edited according to your choice. **HFI0** You can also switch between the scenes or playlist recorded in the built-in memory and those recorded on the memory card.

- 1** In the index screen, move (,) the orange selection frame to the tabs on the top of the screen.
- 2** Select () the location of the scenes you want to play back.
- 3** Return () to the index screen to select the scene.

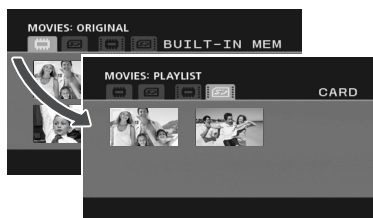

- Original movies in the built-in memory*
 - Original movies on the memory card
 - Playlist in the built-in memory*
 - Playlist on the memory card
- * **HFI0** only.

! IMPORTANT

- Observe the following precautions while the ACCESS indicator is on or flashing. Failing to do so may result in permanent data loss.



- Do not open the memory card slot cover.
- Do not disconnect the power source or turn off the camcorder.
- Do not change the position of the mode dial.
- You may not be able to play back with another AVCHD device the movies you recorded on the memory card with this camcorder. In such case, play back the movies on the memory card using this camcorder.
- You may not be able to play back with this camcorder movies recorded using another AVCHD device.

i NOTES

- Depending on the recording conditions, you may notice brief stops in video or sound playback between scenes.
- You can press **PLAYLIST** on the wireless controller to switch between the original movies index screen and the playlist of the respective memory.

Special playback modes

To enter the special playback modes, you can use the buttons on the LCD panel or wireless controller (□ 14). There is no sound during the special playback modes.

Special playback mode	Initial mode	Operation on the camcorder () or on the wireless controller ()
Fast playback	Normal playback	, : Press or Press again to increase the playback speed 5x → 15x → 60x the normal speed*
Slow playback	Playback pause	, : Press or Press again to increase the playback speed 1/8 → 1/4 the normal speed
Frame-by-frame playback	Playback pause	: Press or to reverse/advance one frame or hold pressed for continuous frame-by-frame playback
Skipping Scenes:		
To the beginning of the next scene	Normal playback	: Push the joystick () : Press
To the beginning of the current scene		: Push the joystick () : Press
To the previous scene		: Push the joystick () twice : Press twice
End special playback	Any special playback mode	: Press : Press

During some special playback modes, you may notice some anomalies (blocky video artifacts, banding, etc.) in the playback picture.

* The speed indicated on the screen is approximate.

ADJUSTING THE VOLUME

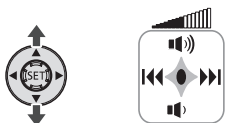

- 1 If the joystick guide does not appear on screen, press **SET** to display it.
- 2 Adjust (**▲▼**) the volume.
 - To turn off the volume, keep the joystick pressed (**▼**) toward **|||** until the volume icon changes to **OFF**.
 - You can press **SET** again to hide the joystick guide during playback.

Selecting Scenes by Recording Date

You can search for all the recordings you made on a particular date, for example, to find all the movies you shot during a special event.



POINTS TO CHECK

Selecting scenes by recording date is available only from the original movies index screen.

Selecting from the List of Recordings

FUNC.
(25)

FUNC.



- 1 Select the original movies index screen.

HF10 You can select the original movies in the built-in memory or on the memory card.

- 2 Open the list of recordings.

FUNC. [SELECT DATE]

- The list of recordings displays all dates in which recordings were made. An orange selection frame appears on the day.
- The thumbnail shows a still image from the first scene recorded on that day. Below it will appear the number of scenes recorded and the total recording time for the same day.

- 3 Change (**▲▼**) the day and move (**◀▶**) to the month or year.

- 4 Change the other fields in the same way to select the desired date and press **SET**.

The index screen will appear with the selection frame on the first scene recorded on the selected date.

Selecting from the Calendar Screen

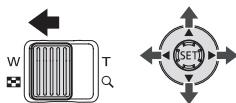

- 1 Select the original movies index screen.

HF10 You can select the original movies in the built-in memory or on the memory card.



2 Move the zoom lever toward W.

- The calendar screen appears.
- Dates that contain scenes (that is, movies were recorded on that date) appear in white. Dates without recordings appear in black.

3 Move (▲▼, ◀▶) the cursor to the desired date.

- When you move the cursor to a date displayed in white, a thumbnail showing a still image from the first scene recorded on that date will be displayed next to the calendar. Below it will appear the number of scenes recorded and the total recording time for the same day.
- You can select (▲) the year or month field and change (◀▶) the year or month to move faster between calendar months.
- You can press (◀◀) or (▶▶) to skip directly to the previous/next date that contains scenes.

4 Press (SET) to return to the index screen.

The orange selection frame will appear on the first scene recorded on the selected date.

i NOTES

- You can change on what day to start the week for the calendar display (□ 94).
- You can press (FUNC.) to return to the index screen at any time.

Selecting the Playback Starting Point from the Movie Timeline

You can display a timeline of the scene and select where to begin the playback. This is very convenient when you want to play back a long scene from a specific point.

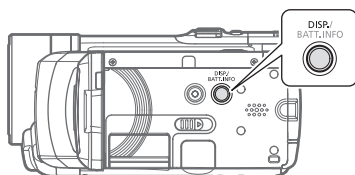

1 In the index screen select the scene you want to view and press (DISP.).

- The timeline screen appears. The large thumbnail will show the first frame of the scene. Below it, the timeline ruler shows frames taken from the scene at fixed intervals.
- Press (DISP.) again to return to the index screen.

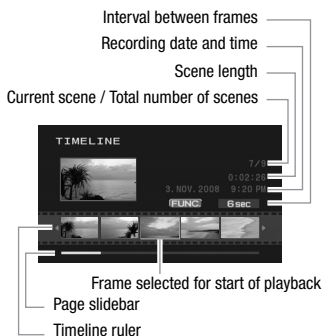

- 2 Select (◀▶) the playback starting point from the timeline ruler.
- 3 Press (SET) to begin the playback.

TO SELECT ANOTHER SCENE

Move (▲▼) the orange selection frame to the large thumbnail and change (◀▶) the scene.

TO MOVE BETWEEN TIMELINE RULER PAGES

Move (▲▼) the orange selection frame to the sidebar below the ruler and display (◀▶) the previous/next 5 frames in the scene.

TO CHANGE THE INTERVAL BETWEEN FRAMES

(FUNC.) ➤ Desired interval ➤ (FUNC.)

Deleting Scenes

You can delete those scenes that you are not interested in keeping. Deleting scenes also allows you to free up space on the memory.



Deleting a Single Scene or All Scenes from a Selected Date

Options

[ALL SCENES (THIS DATE)]
Deletes all the scenes recorded on the same day as the selected scene.
[ONE SCENE]
Deletes only the selected scene.

FUNC.
(25)

(FUNC.)



- 1 Select (▲▼, ◀▶) the scene you want to delete, or a scene recorded on the date you want to delete.

HOLD Select in advance the memory from which you want to delete scenes (36).







- 2 Delete the scene(s).

(FUNC.) ➤ [DELETE] ➤
Desired option ➤ [YES] ➤ [OK] ➤
(FUNC.)



Deleting All Scenes

HF10 Select in advance the memory from which you want to delete scenes (□ 36).

FUNC. 
[MENU] 
[MEMORY OPER.] 
[DEL.ALL MOVIES] 
[YES]*  [OK] 
FUNC.

* Press  twice to interrupt the operation while it is in progress.

! IMPORTANT

- Be careful when deleting original recordings. Once deleted, an original scene cannot be recovered.
- Back up important scenes before deleting them (□ 80).
- Observe the following precautions while the ACCESS indicator is on or flashing (while scenes are being deleted).
 - Do not open the memory card slot cover.
 - Do not disconnect the power source or turn off the camcorder.
 - Do not change the position of the mode dial.

i NOTES

- Deleting a scene from the original index screen also deletes that scene from the playlist.
- To delete all movies and make all recordable space available again you may prefer to initialize the memory (□ 31).
- You may not be able to delete scenes recorded or edited using another device.

Advanced Functions

Cinema Mode: Giving a Cinematic Look to your Recordings

Give your recordings a cinematic look by using the [CINE MODE] recording program. Combine this recording program with the 25 fps progressive frame rate [PF25 PF25] to get the enhanced effect of the 25p Cinema Mode.



FUNC.
(book icon 25)

FUNC.



TO SET THE [CINE MODE] RECORDING PROGRAM

FUNC. >

[PROGRAM AE] >

[CINE MODE] >

FUNC.

TO CHANGE THE FRAME RATE

FUNC. >

[MENU] >

[CAMERA SETUP] >

[FRAME RATE] >

[PF25 PF25] >

FUNC.



Special Scene Recording Programs

Recording in a very bright ski resort or capturing the full colors of a sunset or a fireworks display becomes as easy as selecting a Special Scene recording program. For details about the available options, refer to the sidebar on page 43.



FUNC.
(book icon 25)

FUNC.



FUNC. >

[PROGRAM AE] >

[PORTRAIT] >

Press [SET] to display the Special Scene (SCN) recording programs >

Desired recording program >

FUNC.



i NOTES

- **[NIGHT]**
 - Moving subjects may leave a trailing afterimage.
 - Picture quality may not be as good as in other modes.
 - White points may appear on the screen.
 - Autofocus may not work as well as in other modes. In such case, adjust the focus manually.
- **[FIREWORKS]**
 - To avoid camcorder shake, we recommend using a tripod. Make sure to use a tripod especially in **[CAMERA]** mode, as the shutter speed slows down.
- **[PORTRAIT]/[SPORTS]/[BEACH]/[SNOW]**
 - The picture may not appear smooth during playback.
- **[PORTRAIT]**
 - The blur effect of the background increases the more you zoom in (T).
- **[SNOW]/[BEACH]**
 - The subject may become overexposed on cloudy days or in shaded places. Check the image on the screen.

[PORTRAIT]

The camcorder uses a large aperture, achieving a focus on the subject while blurring other distracting details.



[BEACH]

Use this mode to record on a sunny beach. It prevents the subject from being underexposed.



[SPORTS]

Use this mode to record sports scenes such as tennis or golf.



[SUNSET]

Use this mode to record sunsets in vibrant colors.

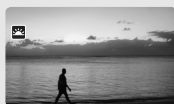

[NIGHT]

Use this mode to record in dimly lit places.



[SPOTLIGHT]

Use this mode to record spotlight scenes.



[SNOW]

Use this mode to record in bright ski resorts. It prevents the subject from being underexposed.



[FIREWORKS]

Use this mode to record fireworks.



Changing the Shutter Speed and Aperture

Use the automatic exposure (AE) program to use functions like the white balance or image effects, or give priority to the exposure value or the shutter speed.

Use faster shutter speeds to record subjects moving quickly; Use slower shutter speeds to add motion blur, emphasizing the feel of movement.

Use low aperture values (larger lens opening) to softly blur the background in a portrait; Use high aperture values (smaller lens opening) to get a wider depth of field, giving a sharp focus all throughout a landscape.



Options

◆ Default value

[PROGRAM AE]◆
The camcorder automatically adjusts the aperture and shutter speed to obtain the optimal exposure for the subject.
[SHUTTER-PRIO.AE]
Set the shutter speed value. The camcorder automatically sets the appropriate aperture value.
[APERTURE-PRIO.AE]
Set the aperture value. The camcorder automatically sets the appropriate shutter speed.

FUNC.
(25)



[FUNC.]

[PROGRAM AE] Desired recording program

[FUNC.]

TO SET THE SHUTTER SPEED OR APERTURE VALUE

When you select [SHUTTER-PRIO.AE] or [APERTURE-PRIO.AE], a numeric value will appear next to the recording program icon.

- 1 If the joystick guide appears on the screen, press to hide it.**
- 2 Adjust () the shutter speed or aperture value to the desired value.**

Shutter speed guidelines

Note that on screen only the denominator is displayed – [250] indicates a shutter speed of 1/250 second, etc.

1/2*, 1/3*, 1/6, 1/12, 1/25
To record in dimly lit places.
1/50
To record under most ordinary conditions.
1/120
To record indoor sports scenes.
1/250, 1/500, 1/1000**
To record from within a moving car or train or to shoot fast-moving subjects such as roller coasters.
1/2000**
To record outdoor sports scenes on sunny days.

* mode only.



** mode only.



Available Aperture Values

[1.8], [2.0], [2.4], [2.8], [3.4], [4.0], [4.8], [5.6], [6.7], [8.0]

NOTES



- When setting a numeric value (aperture or shutter speed), the number displayed will flash if the aperture or shutter speed is not appropriate for the recording conditions. In such case, select a different value.
-  SHUTTER-PRIO.AE
 - If you use a slow shutter speed in dark places, you can obtain a brighter image, but image quality may be lower, and autofocus may not work well.
 - The image may flicker when recording with fast shutter speeds.
-  APERTURE-PRIO.AE
The actual range of values available for selection will vary depending on the initial zoom position.

Mini Video Light

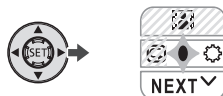

You can turn on the mini video light to shoot video or take photos in dark places.



1 If the joystick guide does not appear on screen, press to display it.

If  does not appear on the joystick guide, push the joystick () toward [NEXT] to display it.

2 Push the joystick () toward .

-  appears on the screen.
- Push the joystick () again to turn the mini video light off.

NOTES

We recommend not using the mini video light while the optional Wide-converter or Tele-converter is attached; its shadow can appear on the screen.

Self Timer



FUNC.
(26)



FUNC.

[MENU]

[CAMERA SETUP]

[SELF TIMER] [ON]

FUNC.

appears.

mode:

In record pause mode, press

[START/STOP].

The camcorder starts recording after a 10-second countdown*. The countdown appears on the screen.

mode:

Press [PHOTO], first halfway to activate the autofocus and then fully.

The camcorder will record the still image after a 10-second countdown*. The countdown appears on the screen.

* 2 seconds when using the wireless controller.

NOTES

Once the countdown has begun, you can press [START/STOP] (when recording movies), press [PHOTO] fully (when recording still images) or turn off the camcorder to cancel the self timer.

Automatic Backlight Correction and Manual Exposure Adjustment

At times, backlit subjects may appear too dark (underexposed) or subjects under very strong lights may appear too bright or glaring (overexposed). To correct this, you can manually adjust the exposure or use the automatic backlight correction.



POINTS TO CHECK

Select a recording mode other than [FIREWORKS].

Automatic Backlight Correction

When shooting subjects with a strong light source behind them, you can have the camcorder automatically correct for the backlight with the press of a single button.

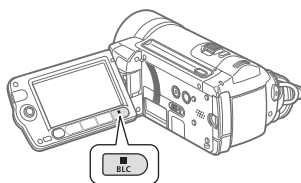

Press [BLC].

- appears.
- Press [BLC] again to end the backlight correction mode.



Manual Exposure Adjustment



1 If the joystick guide does not appear on screen, press  to display it.

If [EXP] does not appear on the joystick guide, repeatedly push the joystick () toward [NEXT] to display it.



2 Push the joystick () toward [EXP].

The exposure adjustment indicator  and the neutral value “±0” appear on the screen.

3 Adjust the () the brightness of the image as required.

The adjustment range and the length of the exposure adjustment indicator will vary depending on the initial brightness of the picture.

4 Press .

- The exposure adjustment indicator will change to white and the exposure will be locked.
- If you operate the zoom during exposure lock, the brightness of the image may change.
- During exposure lock, press  and push the joystick () toward [EXP] again to return the camcorder to automatic exposure.

Manual Focus Adjustment

Autofocus may not work well on the following subjects. In such case, focus manually.

- Reflective surfaces
- Subjects with low contrast or without vertical lines
- Fast moving subjects
- Through wet windows
- Night scenes



 **POINTS TO CHECK**

Adjust the zoom before you start the procedure.



1 If the joystick guide does not appear on screen, press  to display it.

If [FOCUS] does not appear on the joystick guide, repeatedly push the joystick () toward [NEXT] to display it.

2 Push the joystick () toward [FOCUS].

“MF” appears.

3 Push the joystick () or () once to verify if the image is focused.

The center of the screen will be magnified to help you focus more easily. You can also turn off the focus assist function ( 91).

4 Adjust (◀▶) the focus as necessary.

5 Press (SET).

- The focus will be locked.
- During focus lock, press (SET) and push the joystick (▲) toward [FOCUS] again to return the camcorder to autofocus.

Infinity Focus

Use this function when you wish to focus on faraway subjects such as mountains or fireworks.

Instead of step 2 in the previous procedure:

Push the joystick (▲) toward [FOCUS] and hold it for more than 2 seconds.

- ∞ appears.
- Push the joystick (▲) toward [FOCUS] again to return the camcorder to autofocus.
- If you operate the zoom or joystick (◀▶), ∞ changes to “MF” and the camcorder returns to manual focus.

White Balance

The white balance function helps you to accurately reproduce colors under different lighting conditions so that white objects will always look truly white in your recordings.



POINTS TO CHECK

Select a recording mode other than the Special Scene recording programs.

Options

◆ Default value

[AUTO]◆
Settings are automatically set by the camcorder. Use this setting for outdoor scenes.
[DAYLIGHT]
For recording outdoors on a bright day.
[SHADE]
For recording in shaded places.
[CLOUDY]
For recording on a cloudy day.
[TUNGSTEN]
For recording under tungsten and tungsten type (3-wavelength) fluorescent lighting.
[FLUORESCENT]
For recording under warm white, cool white or warm white type (3-wavelength) fluorescent lighting.
[FLUORESCENT H]
For recording under daylight or daylight type (3-wavelength) fluorescent lighting.
[SET]
Use the custom white balance setting to make white subjects appear white under colored lighting.

FUNC.
(25)

()





[FUNC.]

[AWB AUTO]

Desired option*

[FUNC.]

- * When you select [SET], do not press [FUNC.] and continue instead with the following procedure.

TO SET THE CUSTOM WHITE BALANCE

1 Point the camcorder at a white object, zoom in until it fills the whole screen and press .

When the adjustment is completed, stops flashing and stays on. The camcorder retains the custom setting even if you turn off the camcorder.

2 Press [FUNC.] to save the setting and close the menu.

NOTES

- **When you select the custom white balance:**
 - Set the custom white balance in a sufficiently illuminated place.
 - Turn off the digital zoom (90).
 - Reset the white balance when the lighting conditions change.
 - Depending on the light source, may keep flashing. The result will still be better than with [AWB AUTO].
- Custom white balance may provide better results in the following cases:
 - Changing lighting conditions
 - Close-ups
 - Subjects in a single color (sky, sea or forest)
 - Under mercury lamps and certain types of fluorescent lights

- Depending on the type of fluorescent light, optimal color balance may not be obtained with [FLUORESCENT] or [FLUORESCENT H]. If the color looks unnatural, adjust it using [AWB AUTO] or [SET].

Image Effects

You can use the image effects to change the color saturation and contrast to record images with special color effects.



POINTS TO CHECK

Select a recording mode other than the Special Scene recording programs.

Options

◆ Default value

[IMAGE EFFECT OFF] [◆]
Records with no image enhancing effects.
[VIVID]
Emphasizes the contrast and color saturation.
[NEUTRAL]
Tones down the contrast and color saturation.
[LOW SHARPENING]
Records subjects with softened outlines.
[SOFT SKIN DETAIL]
Softens the details in the skin tone area for a more complimentary appearance. To obtain the best effect, use this setting when recording a person in close-up. Note that areas similar to the skin color may lack in detail.

[ CUSTOM]

Allows you to adjust the color depth, brightness, contrast, and sharpness of the image.

[COL.DEPTH]: (–) Shallower colors,
(+) Richer color tonality

[BRIGHTN.]: (–) Darker picture,
(+) Brighter picture

[CONTRAST]: (–) Flatter picture,
(+) More defined light and shade

[SHARPNESS]: (–) Vaguer outlines,
(+) Sharper outlines

FUNC.
( 25)







FUNC. 

[ IMAGE EFFECT OFF] 
Desired option* 

FUNC.

* When you select [ CUSTOM], do not press **FUNC.** and continue instead with the following procedure.

TO SET THE CUSTOM IMAGE EFFECT

- 1 Press  and select (▲▼) the custom setting options.
- 2 Adjust (◀▶) each setting as desired.
- 3 When you finish all the adjustments, press  then **FUNC.** to save the setting and close the menu.

Digital Effects





( 24)

Options

♦ Default value

[ D.EFFECT OFF]♦

Select this setting when you do not intend to use the digital effects.

[ FADE-T] (fade trigger), [ WIPE]

Select one of the faders to begin or end a scene with a fade from or to a black screen.

[ BLK&WHT]*

Records images in black and white.

[ SEPIA]*

Records images in sepia tones for an "old" look.

[ ART]

Select this effect to add "flavor" to your recordings.

* Only these digital effects are available in  mode.



Setting

FUNC.
( 25)





FUNC. 

[ D.EFFECT OFF] 
Desired fader/effect* 

FUNC. **

* You can preview the digital effect on the screen.



**The icon of the selected digital effect appears.



Applying



1 If the joystick guide does not appear on screen, press **SET** to display it.

If  does not appear on the joystick guide, repeatedly push the joystick () toward [NEXT] to display it.

2 Push the joystick () toward .

- The icon of the selected effect turns green.
- Push the joystick () again to deactivate the digital effect (its icon will turn white again).

TO FADE IN

Activate the selected fader in record pause mode (), then press **START/STOP** to start recording with a fade in.

TO FADE OUT

Activate the selected fader while recording () , then press **START/STOP** to fade out and pause the recording.

TO ACTIVATE AN EFFECT

 mode: Activate the selected effect while recording or in record pause mode.

 mode: Activate the selected effect and then press **PHOTO** to record the still image.

NOTES



- When you apply a fader, not only the picture but also the sound will fade in or out. When you apply an effect, the sound will be recorded normally.
- The camcorder retains the last setting used even if you turn off the digital effects or change the recording program.

On-Screen Displays and Data Code

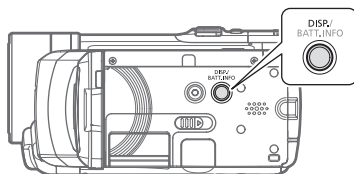
With every scene or still image recorded, the camcorder keeps a data code that includes the date, time and information about the camera setup at the time of recording. While viewing a still image, all the data is displayed in the form of information icons. During movie playback you can select what to display with the [DATA CODE] setting ( 93). You can also turn most on-screen displays on or off.



Repeatedly press **DISP.** to turn the on-screen displays on/off in the following sequence:





- ,  mode:
- All displays on
 - Most displays off*

 mode:

- All displays on
- Data code only
- All displays off

 mode:

- All displays on
- Regular displays only (removes the histogram and information icons)
- All displays off

* The following icons will appear even when all other on-screen displays are turned off: The icons  and  (in  mode), the  icon and AF frames when the autofocus is locked (in  mode), screen markers (both recording modes).

Audio Recording Level



You can adjust the audio recording level for the built-in or for an external microphone. You can display the audio level indicator while recording.





Manual Adjustment of the Audio Recording Level



- 1 If the joystick guide does not appear on screen, press  to display it.

If [ MIC] does not appear on the joystick guide, repeatedly push the joystick () toward [NEXT] to display it.



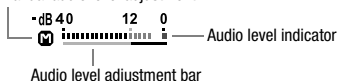

- 2 Push the joystick () toward [ MIC].

The manual adjustment icon  will appear to the left of the audio level indicator and the manual adjustment bar (green) will appear below it.



Manual audio level adjustment



- 3 Adjust () the audio level as necessary.

- Push the joystick () toward  to raise the audio recording level or push it () toward  to lower it.
- As a guideline, adjust the audio recording level so that the audio level meter will go to the right of the -12 dB mark only occasionally.

- 4 Press  to save the setting and hide the joystick guide.

- The audio level selected will be locked and the audio level adjustment bar will disappear from the indicator.
- During manual adjustment, press  and push the joystick () toward [ MIC] to return the camcorder to automatic audio level.



i NOTES

- When the 0 dB mark turns red, the sound may be distorted.
- If the audio level is too high and the sound gets distorted, activate the microphone attenuator (☐ 90).
- We recommend using headphones (☐ 53) to check the sound level while adjusting the audio recording level or when the microphone attenuator is activated.

TO DISPLAY THE AUDIO LEVEL METER

Usually, the audio level indicator will be displayed only after the manual adjustment of the audio recording level. You can choose to display it also when the audio level is adjusted automatically.

FUNC.
(☐ 26)

FUNC.



FUNC. >

[MENU] >

[DISPLAY SETUP] >

[AUDIO LEVEL] > [ON] >

FUNC.

Using Headphones or an External Microphone

Using Headphones

Use headphones for playback or to check the audio level while recording. The headphones are connected to the AV OUT/🎧 terminal, which is used for both the headphones and the audio/video output. Before connecting the headphones, follow the procedure below to change the function of the terminal from AV output to 🎧 (headphones) output.

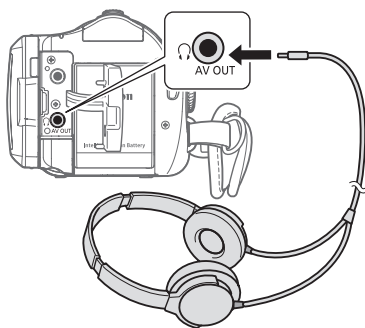

FUNC.
(☐ 25)

FUNC.



FUNC. >

[MENU] >





[SYSTEM SETUP] >

[AV/PHONES] > [PHONES] >

FUNC.



🎧 appears.

TO ADJUST THE VOLUME OF THE HEADPHONES

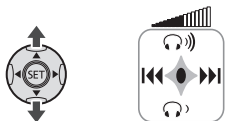

In  mode, adjust the volume of the headphones with the [PHONES VOL.] setting ( 94). In  mode, adjust the headphones volume the same way you adjust the speaker's volume ( 38).



IMPORTANT

- When using headphones, make sure to lower the volume to an appropriate level.
- Do not connect the headphones to the AV OUT/ terminal if the  icon does not appear on the screen. If you connect the headphones while the terminal is set to AV output, only noise will be output.

NOTES

- Use commercially available headphones with a \varnothing 3.5 mm minijack and a cable no longer than 3 m.
- When you turn off the camcorder or change the operating mode, the [AV/PHONES] setting in  mode will return to [ AV].

Using the DM-100 Directional Stereo Microphone

Retract the mini advanced shoe cover and attach the optional DM-100 Directional Stereo Microphone to the mini advanced shoe. For details, refer to the instruction manual of the microphone.

When a compatible accessory is attached to the mini advanced shoe,  will appear on the screen.

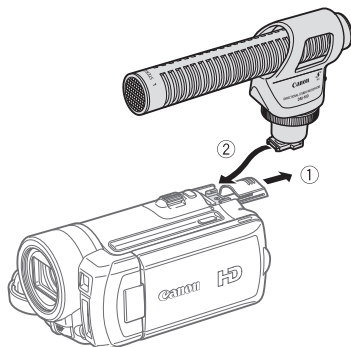

Using other microphones

You can also use commercially available microphones not compatible with the mini advanced shoe, by connecting the external microphone to the MIC terminal. Use commercially available condenser microphones with their own power supply and a cable no longer than 3 m. You can connect almost any stereo microphone with a \varnothing 3.5 mm plug but audio recording levels may vary.

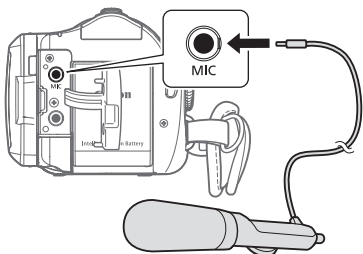

i NOTES

- When an external microphone is connected to the camcorder, [WIND SCREEN] will automatically be set to [OFF OFF OFF].
- Accessories designed for the Advanced Accessory Shoe cannot be used with this camcorder. Look for video accessories bearing this logo to ensure compatibility with the **mini advanced shoe**.
- If the audio level is too high and the sound gets distorted, activate the microphone attenuator (□ 90) or adjust the audio recording level manually (□ 52).



Managing Scenes and the Memory

Creating a Playlist

Create a playlist to play back only the scenes you prefer and in the order of your choice. Moving or deleting scenes in the playlist will not affect the original recordings.

Options

[ALL SCENES (THIS DATE)]
Adds to the playlist all the scenes that were recorded on the same day as the selected scene.
[ONE SCENE]
Adds only the selected scene to the playlist.



FUNC.

(□ 25)



- 1 In the original movies index screen, select (▲▼, ◀▶) the scene you want to add to the playlist, or a scene recorded on the date you want to add to the playlist.**

- 2 Add the scene(s) to the playlist.**

[FUNC.] (◀▶)

[E] ADD TO PLAYLIST (▶)

Desired option (▶) [YES]

- When the operation is completed [ADDED TO PLAYLIST] will be displayed.

- To check the playlist, select (▲▼, ◀▶) the playlist index screen from the tabs on top of the index screen (□ 36).

i NOTES

- H.F.10** The playlist is created on the same memory you are playing back from. Select in advance the location of the scenes to play back (□ 36). You can also copy scenes from the built-in memory to the memory card (□ 57) to include in your playlist movies recorded on both.
- You may not be able to add scenes to the playlist if they were recorded or edited using another device or if there is not enough space available in the memory.

Deleting Scenes from the Playlist

Deleting scenes from the playlist will not affect your original recordings.



Deleting a Single Scene

FUNC.
(□ 25)

FUNC.



- Select (▲▼, ◀▶) the playlist index screen from the tabs on top of the index screen.

H.F.10 You can select the playlist in the built-in memory or the playlist on the memory card (□ 36).

- Select (▲▼, ◀▶) the scene you want to delete.

- Delete the scene.

FUNC. (□ 25) [DELETE] (▶)
[YES]

Deleting the Entire Playlist

FUNC. (▶)
[MENU] (▶)
[MEMORY OPER.] (▶)
[DEL.PLAYLIST] (▶)
[YES] (▶)
FUNC.

Moving Scenes in the Playlist

Move the scenes in the playlist to play them back in the order of your choice.



FUNC.
(□ 25)

FUNC.



- Select (▲▼, ◀▶) the playlist index screen from the tabs on top of the index screen.

H.F.10 You can select the playlist in the built-in memory or the playlist on the memory card (□ 36).

- Select (▲▼, ◀▶) the scene you want to move.

- Open the scene moving screen.

FUNC. (▶) [MOVE]



4 Move (▲▼, ◀▶) the orange marker to the desired position of the scene and press **SET**.

The original position of the scene and the current position of the marker are displayed at the bottom of the screen.

5 Select (▶) [YES] and press **SET** to move the scene.

i NOTES

You may not be able to move scenes in the playlist if there is not enough space available in the memory.

HFI0 Copying Scenes

You can copy original movies or the entire playlist from the built-in memory to the corresponding location on the memory card.



Options for copying original movies

[ALL SCENES]
Copies all the scenes to the memory card.
[ALL SCENES (THIS DATE)]
Copies all the scenes that were recorded on the same day as the selected scene to the memory card.
[ONE SCENE]
Copies only the selected scene to the memory card.

FUNC.
(25)

FUNC.



1 Select one of the index screens of movies recorded in the built-in memory (original movies or playlist).

Refer to *To select which scenes to play back* (36).

2 Select (▲▼, ◀▶) the scene you want to copy to the memory card, or a scene recorded on the date you want to copy.

3 Copy the scene(s).

[FUNC.] (▶) [COPY] (▶)
Desired option* (▶) [YES]** (▶)
[OK] (▶) [FUNC.] (▶)

* Only when copying original movies. From the playlist index screen, only the entire playlist can be copied so this step is not necessary.

** Press **SET** twice to interrupt the operation while it is in progress.

! IMPORTANT

- Observe the following precautions while the ACCESS indicator is on or flashing. Failing to do so may result in permanent data loss.
 - Do not open the memory card slot cover.
 - Do not disconnect the power source or turn off the camcorder.
 - Do not change the position of the mode dial.
- If the memory card slot cover is open, or the LOCK switch on the memory card is set to prevent writing, you will not be able to copy movies to the memory card.



Photos

Refer to this chapter for details on shooting photos – from capturing and playing back images to printing them.

Basic Recording

Taking Photos

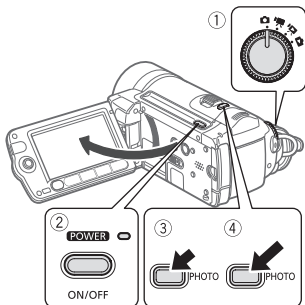



1 Set the mode dial to .

2 Turn on the camcorder.

HiFi You can select the memory to be used for recording still images (□ 30).

3 Press  halfway.

- Once the focus is automatically adjusted,  will turn green and one or more AF frames will appear.
- When you press  on the wireless controller, the still image is

recorded after the autofocus is activated and locked.

4 Press  fully.

The ACCESS indicator will flash as the still image is being recorded.

! IMPORTANT

Observe the following precautions while the ACCESS indicator is on or flashing. Failing to do so may result in permanent data loss.

- Do not open the memory card slot cover.
- Do not disconnect the power source or turn off the camcorder.
- Do not change the position of the mode dial.

i NOTES

- If the subject is not suitable for autofocus,  turns yellow. Adjust the focus manually (□ 47).
- When the subject is too bright, “OVEREXP.” starts flashing. In such case, use the optional FS-H37U ND filter.

Selecting Photo Size and Quality

Still images are recorded as JPG files. As a general rule, select a larger image size for higher quality. Select the **[LW 1920x1080]** size for photos with an aspect ratio of 16:9.



(24)

Options

Image size options and the approximate number of still images that can be recorded on memory cards of various sizes are given in the table below.

FUNC.

(25)

FUNC.



FUNC.

[2048x1536]

Desired image size*

Desired image quality*

FUNC.

* Press to move back and forth between size and quality selection. The number displayed on the right corner indicates the approximate number of images that can be recorded with the current quality/size setting.

NOTES

- Depending on the number of images on the memory card (Windows: 1,800 images or more; Macintosh: 1,000 images or more), you may not be able to transfer images to a computer. Try using a card reader.
- Connection to a PictBridge-compatible printer will not work when the memory card contains 1,800 images or more. For best performance, we recommend keeping the number of images on the memory card under 100.
- The camcorder retains the last setting used even if you set the camcorder to **EASY** mode.

Approximate number of still images on a memory card

♦ Default value

Memory card	128 MB			512 MB			1 GB		
LW 1920x1080	85	130	260	350	525	1,035	705	1,055	2,080
L 2048x1536♦	55	85	175	230	345	700	470	700	1,400
M 1440x1080	115	175	345	470	700	1,365	940	1,400	2,740
SW 848x480 ²	450	635	1,275	1,775	2,515	5,030	3,550	5,030	10,060 ³
S 640x480	585	845	1,525	2,315	3,350	6,030	4,640	6,705	12,070 ³

¹ : [SUPER FINE], : [FINE], : [NORMAL].

² This size is only available for recording a still image at the same time you are recording video (simultaneous recording) (65).

³ Approximate number of still images that can actually be recorded on the memory card. (The maximum number of remaining still images displayed on the screen is 9999.)

- When printing still images, use the following guidelines as a reference for selecting the print size.

Image size	Recommended use
L 2048x1536	To print photos up to A4 size.
M 1440x1080	To print photos up to L size (9 x 13 cm) or postcard size (10 x 14.8 cm).
S 640x480	To send images as e-mail attachments or to post on the Web.
LW 1920x1080, SW 848x480	To print photos with a 16:9 aspect ratio. Wide-sized photo paper is required.

Erasing a Photo Right After Recording It

You can erase the still image recorded last while reviewing it within the time set for the [REVIEW] option or immediately after recording it, if [REVIEW] is set to [OFF OFF].



While reviewing the image immediately after recording:

- 1 Push the joystick (▼) toward .
- 2 Select (▶) [ERASE] and press .

Basic Playback

Viewing Photos

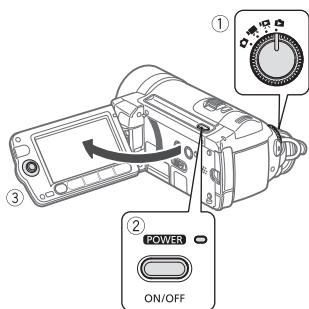

- 1 Set the mode dial to .
- 2 Turn on the camcorder.
- 3 Push the joystick (◀▶) to move between images.

Push the joystick (◀▶) and hold it down to run quickly through the still images.

Image Jump Function

When you have recorded a large number of still images, you can jump 10 or 100 still images at a time.





- 1 If the joystick guide does not appear on screen, press **SET** to display it.
- 2 Push the joystick (**▲**) toward .

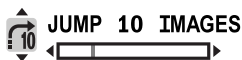

- 3 Select (**▲▼**) [**↔**₁₀ **JUMP 10 IMAGES**] or [**↔**₁₀₀ **JUMP 100 IMAGES**].
- 4 Jump (**◀▶**) the number of images selected and press **SET**.
You can press **SET** again to hide the joystick guide.

! IMPORTANT

- Observe the following precautions while the ACCESS indicator is on or flashing. Failing to do so may result in permanent data loss.
 - Do not open the memory card slot cover.
 - Do not disconnect the power source or turn off the camcorder.
 - Do not change the position of the mode dial.
- The following may not be displayed correctly.
 - Images not recorded with this camcorder.
 - Images edited on or uploaded from a computer.
 - Images whose file names have been changed.

Slideshow

You can play a slideshow of all the still images.

- 1 Select (**◀▶**) the first still image of the slideshow.
- 2 Press **▶||** to play back the still images one after another.
Press **■** to stop the slideshow.

Index Screen

- 1 Move the zoom lever toward **W**.
The still images index screen appears.
- 2 Select (**▲▼**, **◀▶**) an image.
 - Move the orange selection frame to the image you want to view.
 - Repeatedly press **◀◀** or **▶▶** to extend the selection frame and browse through whole index pages.
- 3 Press **SET**.
The index screen closes and the selected image is displayed.



HFTO TO SELECT WHICH STILL IMAGES TO PLAY BACK

You can switch between the still images recorded in the built-in memory and those recorded on the memory card.

- 1 In the index screen, move (**▲**) the orange selection frame to the tabs on the top of the screen.
- 2 Select (**◀▶**) the location of the still images you want to play back.

- 3** Return (▼) to the index screen to select the still image.



-  Still images in the built-in memory
-  Still images on the memory card

Magnifying Photos during Playback

During playback, still images can be magnified up to 5 times.



- 1** Move the zoom lever toward **T**.
- The image is magnified by 2 times and a frame appears indicating the position of the magnified area.
 - To further enlarge the image, move the zoom lever toward **T**. To reduce the magnification to less than 2 times, move it toward **W**.
 -  will appear for images that cannot be enlarged.

- 2** Move (▲▼, ◀▶) the frame to the part of the image you want to see enlarged.

To cancel the magnification, move the zoom lever toward **W** until the frame disappears.

Erasing Photos

You can erase those still images that you are not interested in keeping.



POINTS TO CHECK

- FUNC.** Select in advance the memory from which you want to erase the still images (□ 61).

Erasing a Single Image



- 1** If the joystick guide does not appear on screen, press **SET** to display it.
- 2** Push the joystick (▼) toward .
- 3** Select (▶) [ERASE] and press **SET**.

Erasing All Images

FUNC.
(□ 26)





- FUNC.**
- [MENU]
 - [MEMORY OPER.]
 - [ERASE ALL IMAGES]
 - [YES]* [OK]

FUNC.

* Press **SET** twice to interrupt the operation while it is in progress.

! IMPORTANT

Be careful when erasing images. Erased images cannot be recovered.

i NOTES

Protected images cannot be erased.

Additional Functions

Flash

You can use the flash to record still images in dark places. The flash features the red-eye reduction function.



Options

◆ Default value

(auto) ◆
The flash fires automatically according to the brightness of the subject.
(red-eye reduction, auto)
The flash fires automatically according to the brightness of the subject. The assist lamp lights up to reduce the red-eye effect.
(flash on)
The flash always fires.
(flash off)
The flash does not fire.



1 If the joystick guide does not appear on screen, press **SET** to display it.





If does not appear on the joystick guide, push the joystick () toward [NEXT] to display it.

2 Push the joystick (◀) toward ⚡.

- Repeatedly push the joystick (◀) to cycle between the flash modes.
- The icon of the flash mode appears. ⚡^A disappears after 4 seconds.

3 Press [PHOTO], first halfway to activate the autofocus and then fully to record the still image.

NOTES

- The flash will not fire in the following cases:
 - When you manually adjust the exposure in ⚡^A (auto) or  (red-eye reduction) mode.
 - During auto exposure bracketing.
 - In the [ FIREWORKS] recording program.
- **About the AF-Assist Lamp:** While you press [PHOTO] halfway, if the subject is too dark the assist lamp may light up briefly in order to enable the camcorder to focus more accurately (AF-assist lamp).
 - You can also set [AF AST LAMP] to [ OFF] so the assist lamp does not light up ( 90).
 - The camcorder may not be able to focus even if the AF-assist lamp is on.
- The practical range of the flash is approx. 1 to 2 m. The actual range will depend on the recording conditions.

- The range of the flash decreases in continuous shooting mode.
- For red-eye reduction to be effective, the subject needs to look at the assist lamp. The degree of reduction depends on the distance and on each individual.
- The flash mode cannot be selected when the exposure is locked.
- We recommend not using the flash while the optional Wide-converter or Tele-converter is attached; its shadow can appear on the screen.

Drive Mode: Continuous Shooting and Exposure Bracketing

Take a series of pictures of a moving subject or record the same picture in 3 levels of exposure in order to choose later the picture you like the best.



POINTS TO CHECK

Select a recording mode other than [ FIREWORKS].

Maximum number of continuous shots

Number of shots per second	
 Normal speed	2.5 frames
 High speed	4.1 frames
Using the flash	1.7 frames

Maximum number of continuous shots

60 images

These figures are approximate and vary with the recording conditions and subjects. The actual number of frames per second will be lower when the shutter speed is 1/25 or slower.



Options

◆ Default value

<input type="checkbox"/> SINGLE◆
Records a single still image.
CONT.SHOOT.] (Continuous Shooting), HISPEED CONT.SHOOT.] (High-Speed Continuous Shooting)
Captures a series of still images as long as you hold [PHOTO] pressed down. For the number of shots per second, refer to the sidebar on page 64.
AEB] (Auto Exposure Bracketing)
The camcorder records a still image in three different exposures (dark, normal, light in 1/2 EV steps), allowing you to choose the shot you like the best.

FUNC.
(25)

FUNC.



FUNC.

SINGLE

Desired option

FUNC.

CONTINUOUS SHOOTING/ HIGH-SPEED CONTINUOUS SHOOTING

- 1 Press **[PHOTO]** halfway to activate the autofocus.
- 2 Press **[PHOTO]** fully and hold it pressed down.

A series of still images will be recorded as long as you hold the button pressed.

AUTO EXPOSURE BRACKETING

Press **[PHOTO]**, first halfway to activate the autofocus and then fully to record the still images.

Three still images in different exposures will be recorded.

Capturing a Still Image while Recording Movies (Simultaneous Recording)

You can record still images even while the camcorder is set to mode. Moreover, you can capture the still image at the same time you are recording video.

Still images recorded with simultaneous recording will have the same aspect ratio of movies (16:9).



FUNC.
(25)

FUNC.



FUNC.

[OFF] STILL I.REC OFF]

Desired image size*

Desired image quality*

FUNC.

* Press **[SET]** to move back and forth between size and quality selection. The number displayed on the right corner indicates the approximate number of images that can be recorded with the current quality/size setting.

While recording, or in record pause mode, press **[PHOTO]** to capture the still image.

i NOTES

- The still image cannot be recorded simultaneously while the digital zoom or a digital effect is activated.
- To record still images we recommend using the **[CAMERA]** mode, which offers the best quality for still images.
- **[HF10]** The still image will be recorded to the memory selected for recording still images (**[CAMERA]** 30).

Light Metering Mode

The camcorder measures the light reflected from the subject in order to calculate the optimal exposure settings. Depending on the subject, you may want to change the way the light is measured and evaluated.



Options

◆ Default value

[EVALUATIVE] ◆
Appropriate for standard shooting conditions, including backlit scenes. The camcorder divides the picture into several areas and the light is measured in all of them to achieve the optimal exposure for the subject.
[CENT.WEIGHT.AVERAGE]
Averages the light metered from the entire screen, giving more weight to the subject in the center.

[SPOT]
Meters only the area within the spot AE point frame. Use this setting to adjust the exposure to match the subject in the center of the screen.

FUNC.

(**[CAMERA]** 25)

FUNC.



FUNC. >

[EVALUATIVE] >

Desired option >

FUNC.

Histogram Display

When viewing still images you can display the histogram and the icons of all the functions used at the time of recording. Use the histogram as a reference to verify the correct exposure of the still image.



The area to the right of the histogram represents highlights and the left side represents shadows. A still image whose histogram skews to the right is relatively bright; while one whose histogram peaks to the left, is relatively dark.

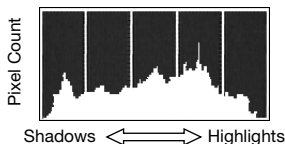



NOTES

The histogram will appear also after recording a still image, while reviewing it within the time set for the [REVIEW] option (or immediately after recording it, if [REVIEW] is set to [OFF OFF]). You can choose to turn off the histogram by pressing [DISP.] (p. 51).

Capturing a Still Image from the Playback Scene

You can capture as still images frames from a scene. The size of the captured still image will be **LW** 1920x1080 and it cannot be changed, but you can select the image quality.



POINTS TO CHECK

Set [TV TYPE] to [16:9 WIDE TV] before using this function (p. 95).

FUNC.
(p. 26)

[FUNC.]



[FUNC.] 

[MENU] 

[SYSTEM SETUP] 

[IMG QUALITY] 

Desired image quality* 

[FUNC.]

* The number displayed at the bottom indicates the approximate number of images that can be recorded with the current quality setting.

TO CAPTURE THE STILL IMAGE

- 1 Play back the scene containing the picture you want to capture.
- 2 Pause the playback at the point you want to capture.
- 3 Press [PHOTO] fully.

NOTES

- The data code of the still image will reflect the date and time of recording of the original scene.
- A still image captured from a scene with lots of fast movement may be blurred.
- **HF10** The still image will be recorded to the memory selected for recording still images (p. 30).

Protecting Photos

You can protect still images from accidental erasure.



FUNC.
(p. 25)

[FUNC.]



- 1 Open the image selection screen.

[FUNC.]  [ON PROTECT]
[ON PROTECT] appears on the screen.

- 2 Select (◀▶) the still image you want to protect.

3 Press **SET** to protect the still image.

ON appears on the bottom bar and the image cannot be erased. Press **SET** again to cancel the image protection.

4 Repeat steps 2-3 to protect additional images or press **FUNC.** twice to close the menu.

! IMPORTANT

Initializing the memory (□ 31) will permanently erase all recordings, including protected still images.

HF10 Copying Photos

You can copy still images from the built-in memory to the memory card and vice versa.



✓ POINTS TO CHECK

Select in advance the memory from which you want to copy the still images (□ 61).

Copying a Single Image

FUNC.
(□ 25)

FUNC.



FUNC. **▶**

[COPY] **▶** **[YES]** **▶**

FUNC. **▶**

Copying Images from the Index Screen

Options

[ALL IMAGES]
Copies all the still images.
[ONE IMAGE]
Copies only the selected still image.

FUNC.

(□ 25)

FUNC.



1 Move the zoom lever toward **W**.

The still image index screen appears.

2 Select the memory from which you want to copy the still images.

Refer to *To select which still images to play back* (□ 61).

3 If you want to copy only one image, select (**▲▼**, **◀▶**) the still image you want to copy.

4 Copy the still image(s).

FUNC. **▶** **[COPY]** **▶**

Desired option **▶** **[YES]*** **▶** **[OK]**** **▶**

FUNC.

* When copying all the still images, press **SET** twice to interrupt the operation while it is in progress.

** Only when copying all still images.

! IMPORTANT

Observe the following precautions while the **ACCESS** indicator is on or flashing. Failing to do so may result in permanent data loss.

- Do not open the memory card slot cover.
- Do not disconnect the power source or turn off the camcorder.
- Do not change the position of the mode dial.



i NOTES

- If there is not enough space on the destination memory, the camcorder will copy as many still images as possible before stopping the operation.
- If the memory card slot cover is open, or the LOCK switch on the memory card is set to prevent writing, you will not be able to copy still images to the memory card.

You can also use the following functions...

The following functions and features of the camcorder can be used either for shooting video or for taking photos.

The way to set and use them was already explained in detail, so we refer you to the relevant page in the “Video” section.

- Zoom (□ 34)
- Quick Start (□ 34)
- Recording programs (□ 42, 43)
- Mini video light (□ 45)
- Self timer (□ 46)
- Automatic backlight correction and manual exposure adjustment (□ 46)
- Manual focus adjustment (□ 47)
- White balance (□ 48)
- Image effects (□ 49)
- Digital effects (□ 50)

Printing Photos

Printing Photos (Direct Print)

The camcorder can be connected to any PictBridge-compatible printer. You can mark in advance the still images you want to print and set the desired number of copies as a print order (□ 73).

PictBridge

Canon printers: SELPHY printers of the CP, DS and ES series and inkjet printers marked with the PictBridge logo.







Connecting the Camcorder to the Printer

1 Insert the memory card containing the still images you want to print.

HF10 Select in advance the memory from which you want to print the still images (□ 61).



2 Turn on the printer.

3 Connect the camcorder to the printer using the supplied USB cable.



- Connection . Refer to *Connection Diagrams* (□ 77).
- If the device type selection screen appears, select [ PC/PRINTER] and press .
-  appears and changes to .

- The  (Print/Share) button lights up and the current print settings will be displayed for approx. 6 seconds.

! IMPORTANT

- If  continues to flash (for more than 1 minute) or if  does not appear, the camcorder is not correctly connected to the printer. In such case, disconnect the USB cable and turn off the camcorder and the printer. After a short while, turn them on again, set the camcorder to  mode and restore the connection.
- During the following operations, even if you connect a printer to the camcorder it will not be recognized.
 - Erasing all still images
 - Erasing all transfer orders
 - Erasing all print orders

i NOTES

-  will appear for images that cannot be printed.
- We recommend powering the camcorder using the compact power adapter.
- Refer also to the printer's instruction manual.
- If you have no intention to use the optional DW-100 DVD Burner, you can set [USB SETTING] to [ PC/PRINTER] ( 94) so the device type selection screen does not appear every time you connect the camcorder to a printer.

Printing with the (Print/Share) Button

You can print a still image without changing the settings simply by pressing .

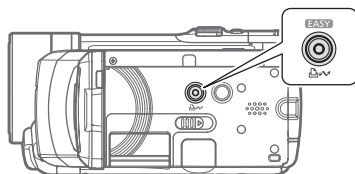

1 Select (◀▶) the still image you wish to print.

2 Press .

- Printing starts. The  button flashes and stays on when the printing is completed.
- To continue printing, select (◀▶) another still image.

Selecting the Print Settings

You can select the number of copies and other settings for printing. The setting options vary depending on your printer model.





Options

[PAPER]
[PAPER SIZE]: Available paper sizes vary depending on the printer model.
[PAPER TYPE]: Select [PHOTO], [FAST PHOTO], [PLAIN] or [DEFAULT].
[PAGE LAYOUT]: Select [DEFAULT], [BORDERED] or one of the following page layouts. [BORDERLESS]: The image is enlarged and may be slightly cropped at the edges to fit the paper. [2-UP], [4-UP], [8-UP], [9-UP], [16-UP]: Refer to the sidebar below.
[] (Date print)
Select [ON], [OFF] or [DEFAULT].
[] (Print Effect)
Available only with printers compatible with the Image Optimize function. Select [ON], [OFF] or [DEFAULT]. Canon inkjet/SELPHY DS printers: You can also select [VIVID], [NR] and [VIVID+NR].
[] (Number of Copies)
Select 1-99 copies.

NOTES

Print setting options and [DEFAULT] settings vary depending on the printer model. For details, refer to the printer's instruction manual.

Printing after Changing the Print Settings



- 1 If the joystick guide does not appear on screen, press to display it.**
- 2 Push the joystick () toward .**
The print settings menu appears.

Printing multiple images on the same sheet [2-UP], [4-UP], etc.

When using Canon printers you can print the same still image multiple times on the same sheet of paper. Use the following table as a guideline for the recommended number of copies depending on the [PAPER SIZE] setting.

[PAPER SIZE] →	[CREDITCARD]	[9 x 13 cm]	[10 x 14.8 cm]	[A4]
Canon printer ↓				
Inkjet printers	–	–	2, 4, 9 or 16 ¹	4
SELPHY DS				
SELPHY CP/ES	2, 4 or 8 ²	2 or 4	2 or 4	–

¹ You can also use the special sticker sheets.

² With the [8-UP] setting, you can also use the special sticker sheets.

SELPHY CP: When you use the wide-sized photo paper with the [DEFAULT] setting, you can also use [2-UP] or [4-UP].

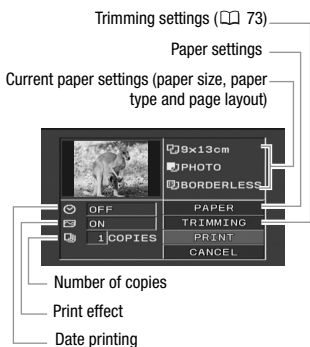

3 In the print settings menu, select (▲▼, ◀▶) the setting you want to change and press (SET).

4 Select (▲▼) the desired setting option and press (SET).

5 Select (▲▼, ◀▶) [PRINT] and press (SET).

- Printing starts. The print settings menu disappears when the printing is completed.
- To continue printing, select (◀▶) another still image.

TO CANCEL THE PRINTING

- 1 Press (SET) while printing.
- 2 Select (◀) [OK] and press (SET).

WHEN YOU HAVE FINISHED PRINTING

Disconnect the cable from the camcorder and printer and turn off the camcorder.

PRINT ERRORS

If an error occurs while printing, an error message, for example [NO PAPER], will appear on the camcorder. Solve the problem referring to the error message list (□ 106) and to the printer's instruction manual.

- **Canon's PictBridge-compatible printers:** If printing does not resume automatically after you solved the problem, select [CONTINUE] and press (SET) to resume printing. If that option is not available, select [STOP] and press (SET) and then restart printing from the beginning.
- **Other printers or if the error still persists with a Canon printer:** If printing does not resume automatically, disconnect the USB cable and turn off the camcorder. After a short while, turn on the camcorder and restore the USB connection.

IMPORTANT

- You may not be able to print correctly with a PictBridge-compatible printer still images whose file names have been changed or that were recorded, created, edited or changed with any device other than this camcorder.
- If [BUSY] does not disappear, disconnect the USB cable and restore the connection after a short while.

Trimming Settings

Set the paper size and page layout before changing the trimming settings.

1 Open the print settings menu.

Refer to steps 1-2 in *Printing after Changing the Print Settings* (□ 71).



2 Select (▲▼, ◀▶) [TRIMMING] and press (SET).

The trimming frame appears.

3 Change the size of the trimming frame.

- Move the zoom lever toward **T** to shrink the frame, and move it toward **W** to enlarge it. Press (SET) to change the orientation of the frame (portrait/landscape).
- To cancel the trimming settings, move the zoom lever toward **W** until the trimming frame disappears.



4 Move (▲▼, ◀▶) the trimming frame to the area of the picture you want to print.

5 Press (FUNC.) to return to the print settings menu.

- The print area selected will be indicated by a green frame within the still image's thumbnail.
- To change other print settings and print the area you selected refer to steps 3-5 in *Printing after Changing the Print Settings* (□ 71).

(i) NOTES

- The trimming settings apply to one image only.
- The trimming settings are canceled in the following cases:
 - When you turn off the camcorder.
 - When you disconnect the USB cable.
 - When you expand the trimming frame beyond its maximum size.
 - When you change the [PAPER SIZE] setting.
- You may not be able to set the trimming settings for a still image not recorded with this camcorder.

Print Orders

You can mark in advance the still images you want to print and set the desired number of copies as a print order. Later, you can easily print out the print orders by connecting the camcorder to a PictBridge-compatible printer (□ 69). You can set print orders for up to 998 still images.



Selecting Still Images for Printing (Print Order)

POINTS TO CHECK

Set the print orders before connecting the USB cable to the camcorder.

FUNC.
(25)



1 Open the image selection screen.

[PRINT ORDER]
 0 appears on the screen.

2 Select () the still image you want to mark with a print order.

3 Press to set the print order.

The number of copies appears in orange.

4 Set () the number of copies desired and press .

To cancel the print order, set the number of copies to 0.

5 Repeat steps 2-4 to mark additional images with print orders or press twice to close the menu.

Printing the Still Images Marked with Print Orders

FUNC.
(26)



1 Connect the camcorder to the printer using the supplied USB cable.

Connection (). Refer to *Connection Diagrams* (77).

2 Open the print settings menu.

[MENU]
 [PRINT]

- The print settings menu appears.
- If there are no still images marked with print orders, [SET PRINT ORDER] appears.

3 Select (,) [PRINT] and press .

Printing starts. The print settings menu disappears when the printing is completed.

NOTES

- Depending on the connected printer, you can change some print settings before step 3 (70).
- To cancel the printing, refer to page 72.
- **Restarting Printing:** Open the print settings menu as explained in step 2. In the print settings menu, select [RESUME]* and press . The remaining images will be printed. Printing cannot be restarted when the print order settings have been changed or if you deleted a still image with print order settings.

* In case the print order was interrupted after the first still image, this menu option will appear as [PRINT] instead.

Erasing All Print Orders

FUNC.
(25)



[MENU]
[MEMORY OPER.]
[ERASE ALL ORD]
[YES]



4



External Connections

This chapter explains how to connect your camcorder to an external device such as a TV, VCR, or computer.

Terminals on the Camcorder

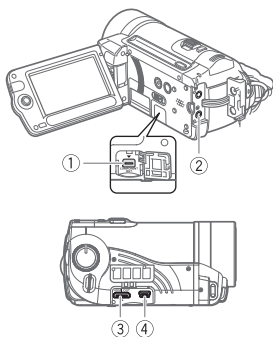

① COMPONENT OUT Terminal*

Access: Open the LCD panel and the terminal cover. The component video terminal is for video only. When you use connection **(B)** do not forget the audio connections using the AV OUT/**(Q)** terminal.



② AV OUT/**(Q)** Terminal

Access: Open the rear terminal cover. Sound from the built-in speaker will be muted while the STV-250N Stereo Video Cable is connected to the camcorder.



③ HDMI OUT Mini Terminal*

Access: Move the grip belt and open the terminal cover. The HDMI OUT mini terminal offers a high-quality digital connection that combines audio and video in a single convenient cable.



④ USB Terminal

Access: Move the grip belt and open the terminal cover.

* When connecting a cable to the camcorder, make sure to align the triangle marks on the cable's connector and on the camcorder's terminal (▶◀).

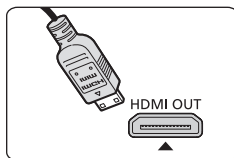
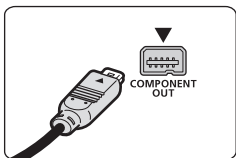

Attaching the Ferrite Core

Attach the enclosed ferrite core before you connect the STV-250N Stereo Video Cable to the camcorder.

Attach the ferrite core to the cable about 10 mm from the plug end (the plug to be connected to the camcorder) of the STV-250N Stereo Video Cable.

Pass the cable through the centre of the core and wrap it around the core, then close the unit until it clicks shut.

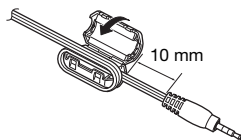

Connection Diagrams





Connections that can be used to connect the camcorder to a TV are listed in falling order of picture quality. Connections that require cables or accessories not supplied with the camcorder are marked with an asterisk; prepare the necessary equipment in advance.

Connection (A)* Type: Digital • Quality: High definition • Output only
 Connect to a high-definition TV (HDTV) with an HDMI input terminal.

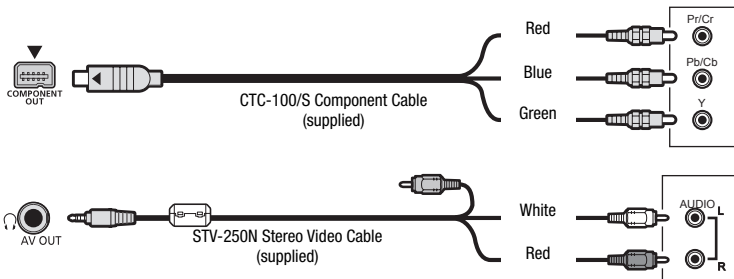



Connection (B) Type: Analog • Quality: Depends on the settings • Output only
 Connect to a high-definition TV (HDTV) or a standard TV with component video input terminals. Change the following settings on the camcorder:
 - [COMP.OUT] according to the TV set (standard or high definition) (95)
 - [AV/PHONES] to [**AV**] AV (94)



Connection  **Type: Analog • Quality: Standard definition • Output only**
 Connect to a standard TV or a VCR with audio/video input terminals. Change the following settings on the camcorder:
 - [TV TYPE] according to the TV set (widescreen or 4:3), if the TV cannot automatically detect and change the aspect ratio ( 95)
 - [AV/PHONES] to [ AV] ( 94)



Connection  **In all respects, exactly the same connection as connection  above.**
 Connect to a standard TV or VCR with SCART input terminal. Requires a SCART adapter (commercially available).



Connection  **Type: Digital data connection**
 Connect to a computer to transfer and back up your recordings, to the optional DW-100 DVD Burner to create DVD discs from them, or to a printer to print out photos.

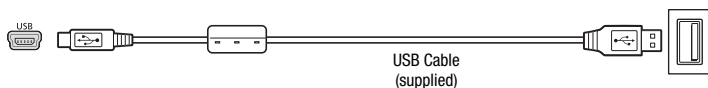



Playback on a TV Screen

Connect the camcorder to a TV to enjoy your recordings with family and friends. Playback on an HDTV using one of the high-definition connections will ensure the best playback quality.



1 Turn off the camcorder and the TV.

2 Connect the camcorder to the TV.

Refer to *Connection Diagrams* (77) and select the most appropriate connection for your TV.



3 Turn on the connected TV.

On the TV, select as the video input the same terminal to which you connected the camcorder. Refer to the instruction manual of the connected TV.

4 Turn on the camcorder and set it to mode (36) or mode (60).



Start the playback of movies or still images.

NOTES

- We recommend powering the camcorder using the compact power adapter.
- Sound from the built-in speaker will be muted while the STV-250N Stereo Video Cable is connected to the camcorder.
- Connection  or : When you play back your 16:9 movies on standard TV sets with a 4:3 aspect ratio, the TV set will switch automatically to widescreen mode if it is compatible with the WSS system. Otherwise, change the aspect ratio of the TV manually.

About the HDMI terminal

The HDMI (High-Definition Multimedia Interface) connection () is a convenient all-digital connection using a single cable for both video and audio. When you connect the camcorder to an HDTV equipped with an HDMI terminal, you can enjoy video and audio playback at the highest quality.

- The HDMI OUT mini terminal on the camcorder is for output only. Do not connect it to an HDMI output terminal on an external device, as this may damage the camcorder.
- Correct operation cannot be guaranteed when connecting the camcorder to DVI monitors.
- Depending on the HDTV, correct playback of personal video content may not be possible using connection . Try one of the other connections.
- While the camcorder is connected to an HDTV using connection , there will no video output from other terminals.

Saving and Backing Up Your Recordings

Backing Up Your Recordings on a Computer

Movies recorded with this camcorder are saved on the memory card or in the built-in memory (**HFI0** only). Because space on the memory is limited, make sure to back up your movies onto a computer on a regular basis.

PIXELA ImageMixer 3 SE

With the software supplied on the **PIXELA ImageMixer 3 SE** CD-ROM you can select scenes and back them up on your computer's hard disk, and restore your backup files back to the camcorder if necessary. On the computer, you can neatly organize all your video recordings into albums and add comments for quick and easy searches; you can also edit scenes, convert and resize them to upload them to your Web site or to take with you on your portable video player and more. For details about the functions available, refer to the software's instruction manual (PDF file). For details about installing the software refer to **PIXELA ImageMixer 3 SE** *Installation Guide*.

Saving your Recordings without a Computer

The following options are also available if you prefer to save your recordings without having to use a computer.

- Use the optional DW-100 DVD Burner to create high-definition (AVCHD) discs of your movies and Photo DVDs of your still images (□ 80).
- Connect the camcorder to an external recording device (DVD or HDD recorder, VCR, etc.) to save standard-definition copies of your movies (□ 83).

IMPORTANT

When the camcorder is connected to a computer: Do not access, change or delete folders and files in the camcorder directly from the computer as this may result in permanent data loss. Always back up your recordings to the computer and restore the backup files to the camcorder using only the supplied software ImageMixer 3.

Authoring High-Definition (AVCHD) Discs and Photo DVDs

You can connect the camcorder to the optional DW-100 DVD Burner to create high-definition DVD discs (AVCHD specifications). This way, you can preserve your video recordings in the highest video quality available. You can also create Photo DVDs from your still images that you can play back with most standard DVD players.



Refer to this section along with the relevant sections in the instruction manual of the DW-100.



(□ 24)

Options for creating AVCHD discs

(mode)

[ALL SCENES]
Add all the scenes to the disc(s).
[REM.SCENES]
Add only those scenes that have not been previously added to a disc.
[PLAYLIST]
Add only the scenes included in the playlist (□ 55).

Options for creating Photo DVDs

(mode)

[ALL IMAGES]
Add all the still images to the slideshow on the disc.
[TRANS.ORD]
Add only still images marked with transfer orders (□ 86).

Preparations on the Camcorder

1 Turn on the camcorder and set it to mode to create high-definition discs of your movies or mode to create Photo DVDs of your still images.

- Power the camcorder using the compact power adapter.
- **HF10** Select in advance the memory from which you want to add the scenes (□ 36) or still images (□ 61).

2 Select the scenes or still images you want to add to the disc.

[FUNC.] [MENU]
 [SYSTEM SETUP]
 [ADD TO DISC] Desired option
 [FUNC.]

Connecting to the DW-100 DVD Burner and Creating a Disc

1 Turn on the DVD Burner.

DW-100 Refer to *Creating DVDs*.

2 Connect the camcorder to the DVD Burner using the USB cable.

- Connection (). Refer to *Connection Diagrams* (□ 77) and **DW-100** *Connections*.
- If the device type selection screen appears, select [DVD BURNER] and press ().
- When the connection is completed, [NO DISC] will be displayed.

3 Insert a brand new disc into the DVD Burner.

- Use the OPEN/CLOSE button on the DVD Burner to open and close the disc tray.
- After the disc is recognized, an information screen will display the type of DVD you are creating and the estimated time and number of discs it will require (based on the disc you inserted).
- If you inserted a DVD-RW disc that already contains data, [THE DISC CONTAINS DATA] will be displayed. To overwrite the data (erasing the previous content of the disc), press (), select [YES] and press () again.

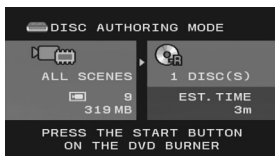

4 Press the start button on the DVD Burner.

- A progress bar will be displayed on the screen.
- After pressing the start button (while the current disc is being written) the operation cannot be canceled.

WHEN THE DATA REQUIRES MULTIPLE DISCS

- After a disc is finalized it will be ejected automatically and [INSERT A NEW/BLANK DISC AND CLOSE THE DISC TRAY] will appear. Insert the next disc and close the disc tray.
- When the last disc is finalized, [TASK COMPLETED] will be displayed. Take out the disc and close the disc tray.

TO CREATE AN ADDITIONAL COPY OF THE SAME DISC

After the operation is finished, [INSERT A NEW/BLANK DISC] will be displayed again. Insert a brand new disc and close the disc tray.

! IMPORTANT

- While the camcorder is connected to the DVD Burner, do not open the memory card slot cover and do not remove the memory card.
- Observe the following precautions while the ACCESS indicator on the camcorder is on or flashing. Failing to do so may result in permanent data loss.
 - Do not open the memory card slot cover.
 - Do not disconnect the USB cable.
 - Do not disconnect the power source or turn off the camcorder or the DVD Burner.
 - Do not change the position of the mode dial.
- High-definition (AVCHD) discs created using the optional DW-100 DVD Burner can be played back only with AVCHD-compatible DVD players. Do not insert a high-definition disc into a DVD player that is not compatible with AVCHD specifications as you may not be able to eject the disc.
- For important information on handling your discs, refer to **DW-100** > *Cautions on handling*.

Playing Back AVCHD Discs Using the DW-100 DVD Burner

You can use the optional DW-100 DVD Burner and the camcorder also to play back high-definition (AVCHD) discs on a TV. This is very convenient, for example to play back your discs even in a location where an AVCHD-compatible DVD player is not available.





1 Connect the camcorder to the TV.

Refer to *Connection Diagrams* (□ 77). Select connection (A) or (B) to enjoy high-definition playback.

2 Turn on the DVD Burner and set it to Disc Playback mode.

DW-100 Refer to *Playing DVDs*.

3 Connect the camcorder to the DVD Burner using the USB cable.

- Connection (D). Refer to *Connection Diagrams* (□ 77) and **DW-100** *Connections*.
- If the device type selection screen appears, select [DVD BURNER] and press (SET).

4 Insert the disc you want to play back into the DVD Burner.

- Use the OPEN/CLOSE button on the DVD Burner to open and close the disc tray.
- After the disc is recognized, the disc's content will be displayed in an index screen.

5 Select (▲▼, ◀▶) the scene you want to play back and press (SET) to begin the playback.

TO PLAY BACK PHOTO DVDs

Photo DVDs are created using DVD-Video specifications (standard definition) and cannot be played back using the DVD Burner. Play back your Photo DVDs using standard DVD players.

If your computer has a DVD drive, you can play back the slideshow as a DVD and you can also access the individual still images as JPG files.

IMPORTANT

While the camcorder is connected to the DVD Burner, do not open the memory card slot cover and do not remove the memory card.

NOTES

- Only AVCHD discs created with the DW-100 DVD Burner can be played back using the DVD Burner.
- The FUNC. menu and setup menus cannot be accessed while the camcorder is connected to the DVD Burner.
- Some of the special playback modes (frame advance/reverse, slow playback, fast playback at 60x speed, etc.) cannot be used for disc playback.

Copying your Recordings to an External Video Recorder

You can copy your recordings by connecting the camcorder to a VCR or a digital video device. Video output will be in standard definition, although the original scenes are in high definition.



Connecting

Connect the camcorder to the VCR using Connection (C) or (C1). Refer to *Connection Diagrams* (□ 77).

Recording

- 1 External device: Load a blank cassette or disc and set the device to record pause mode.**
- 2 Camcorder: Locate the scene you wish to copy and pause playback shortly before the scene.**
- 3 Camcorder: Resume the movie playback.**
- 4 External device: Begin recording when the scene you wish to copy appears. Stop recording when copying is complete.**
- 5 Camcorder: Stop playback.**

NOTES

- We recommend powering the camcorder using the compact power adapter.
- By default, on-screen displays will be embedded in the output video signal. You can change the displays by repeatedly pressing **[DISP.]** (□ 51).

Transferring Photos to a Computer (Direct Transfer)

With the software supplied on the **DIGITAL VIDEO Solution Disk** CD-ROM you can transfer still images to a computer simply by pressing .

Refer also to the relevant sections in the “Digital Video Software” instruction manual (PDF file).



Preparations

Install the software before you connect the camcorder to the computer for the first time. (Windows users only: you also need to select CameraWindow's auto-launch setting.) After that, just connect the camcorder to the computer (steps 2 and 3) and proceed directly to transfer the still images (□ 85).



1 Install the supplied Digital Video Software.

[DVSD] > Refer to *Installing the Software*.

2 Set the camcorder to mode.

[HF10] Select in advance the memory from which you want to transfer still images (□ 61).

3 Connect the camcorder to the computer using the USB cable.

- Connection . Refer to *Connection Diagrams* (□ 77).
- If the device type selection screen appears, select **[PC/PRINTER]** and press **[SET]**.
- The direct transfer menu appears on the camcorder screen and the  button lights up.

FIRST-TIME CONNECTION TO A COMPUTER RUNNING WINDOWS

Windows users only: The first time you connect the camcorder to the computer, you need also to select the CameraWindow auto-launch setting.

[DVSD] > Refer to *When Connecting the Camcorder to a Computer*.



! IMPORTANT

- While the camcorder is connected to the computer, do not open the memory card slot cover and do not remove the memory card.
- Observe the following precautions while the ACCESS indicator is on or flashing. Failing to do so may result in permanent data loss.
 - Do not open the memory card slot cover.
 - Do not disconnect the USB cable.
 - Do not turn off the camcorder or the computer.
 - Do not change the position of the mode dial.
- Operation may not work correctly depending on the software and the specifications/settings of your computer.
- If you wish to use the image files on your computer, make copies of them first. Use the copied files, retaining the originals.
- During the following operations, even if you connect the camcorder to the computer it will not be recognized.
 - Erasing all still images
 - Erasing all transfer orders
 - Erasing all print orders

i NOTES

- We recommend powering the camcorder using the compact power adapter.
- Refer also to the computer's instruction manual.
- **Users of Windows Vista, Windows XP and Mac OS X:** Your camcorder is equipped with the standard Picture Transfer Protocol (PTP) allowing you to transfer still images (JPEG only) simply by connecting the camcorder to a

computer using the USB cable without having to install the supplied software.

- If you have no intention to use the optional DW-100 DVD Burner, you can set [USB SETTING] to [PC/PRINTER] (p. 94) so the selection screen does not appear every time you connect the camcorder to a computer.

Transferring Still Images



Automatic Transfer Options

All the relevant still images will be transferred to the computer in one batch and their thumbnails will be displayed on the computer.

[ALL IMAGES]
Transfers all still images.
[NEW IMAGES]
Transfers only those still images that have not yet been transferred to the computer.
[TRANSFER ORDERS]
Transfers still images marked with transfer orders (p. 86).

Manual Transfer Options

You can select the still image(s) to transfer.

[SELECT & TRANSFER]
Select the still image(s) to transfer.
[WALLPAPER]
Select a still image and set it as your computer's desktop background.

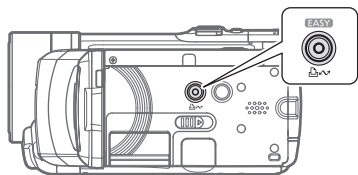

AUTOMATIC TRANSFER OPTIONS

Select (▲▼) a transfer option and press .

- The camcorder returns to the transfer menu once the transfer is completed.
- To cancel the transfer, select (◀▶) [CANCEL] and press (SET), or press [FUNC.].

MANUAL TRANSFER OPTIONS

- 1 Select (▲▼) a transfer option and press .
- 2 Select (◀▶) the image you wish to transfer and press .
 - [SELECT & TRANSFER]: Repeat this step to select other still images to transfer.
 - The button will flash while the images are being transferred.
- 3 Press [FUNC.] to return to the transfer menu.

i NOTES

When the camcorder is connected to the computer and the image selection screen is displayed, press [FUNC.] to return to the transfer menu.

Transfer Orders

You can mark in advance the still images you want to transfer to the computer as transfer orders. You can set transfer orders for up to 998 still images.



Selecting Still Images to Transfer (Transfer Order)

Set the transfer orders before connecting the camcorder to the computer.

HF10 Select in advance the memory from which you want to transfer still images (□ 61).

FUNC.
(□ 25)

[FUNC.]



- 1 Open the image selection screen.
 - [FUNC.] [SELECT & TRANSFER ORDER]
 - appears on the screen.
- 2 Select (◀▶) the still image you want to mark with a transfer order.
- 3 Press (SET) to set the transfer order. A checkmark ✓ appears in the box next to the transfer order icon . Press (SET) again to cancel the transfer order.



- 4 Repeat steps 2-3 to mark additional images with transfer orders or press [FUNC.] twice to close the menu.**

TO TRANSFER THE STILL IMAGES MARKED WITH TRANSFER ORDERS

Connect the camcorder to the computer and select [TRANSFER ORDERS] in the transfer menu (p. 85).

Erasing All Transfer Orders

FUNC.

(p. 26)

[FUNC.]



[FUNC.] >

[MENU] >

[MEMORY OPER.] >

[ERASE ALL TRANSFER ORD.] >

[YES] >

[FUNC.]



Additional Information

This chapter contains troubleshooting advice, screen messages, handling and maintenance tips, and other information.

Appendix: Menu Options Lists

Menu items not available appear grayed out in the FUNC. menu or in black in the setup menus. For details about how to select an item, refer to *Using the Menus* (□ 25). For details about each function, see the reference page. Menu options without a reference page are explained below the tables.

FUNC. Menu - Recording Modes

Menu item	Setting options			
Recording programs	[] PROGRAM AE], [] SHUTTER-PRIO.AE], [] APERTURE-PRIO.AE]	●	●	43
	[] CINE MODE]	●	–	42
	[] PORTRAIT], [] SPORTS], [] NIGHT], [] SNOW], [] BEACH], [] SUNSET], [] SPOTLIGHT], [] FIREWORKS]	●	●	42
Light metering mode	[] EVALUATIVE], [] CENT.WEIGHT.AVERAGE], [] SPOT]	–	●	66
White balance	[] AUTO], [] DAYLIGHT], [] SHADE], [] CLOUDY], [] TUNGSTEN], [] FLUORESCENT], [] FLUORESCENT H], [] SET]	●	●	48
Image effects	[] IMAGE EFFECT OFF], [] VIVID], [] NEUTRAL], [] LOW SHARPENING], [] SOFT SKIN DETAIL], [] CUSTOM]	●	●	49
Digital effects	[] D.EFFECT OFF], [] FADE-T], [] WIPE], [] BLK&WHT], [] SEPIA], [] ART]	●	–	50
	[] D.EFFECT OFF], [] BLK&WHT], [] SEPIA]	–	●	
Drive mode	[] SINGLE], [] CONT.SHOOT.], [] HISPEED CONT.SHOOT.], [] AEB]	–	●	64



Menu item	Setting options			
Recording mode	[EXP] HIGH QUALITY 17 Mbps], [XP] HIGH QUALITY 12 Mbps], [SP] STANDARD PLAY 7 Mbps], [LP] LONG PLAY 5 Mbps]	●	–	33
Still image simultaneous recording	[OFF] STILL I.REC OFF], [LW 1920x1080], [SW 848x480]	●	–	65
	[S] SUPER FINE], [F] FINE], [N] NORMAL]			
Still image size/quality	[LW 1920x1080], [L 2048x1536], [M 1440x1080], [S 640x480]	–	●	58
	[S] SUPER FINE], [F] FINE], [N] NORMAL]			







FUNC. Menu - Playback Modes

Menu item	Setting options			
HFI0 [COPY]	Original movies: [ALL SCENES], [ALL SCENES (THIS DATE)], [ONE SCENE], [CANCEL]	●	–	57
	Scenes in the playlist: [NO], [YES]			
	From the index screen: [ALL IMAGES], [ONE IMAGE], [CANCEL]	–	●	68
	While displaying a single still image: [NO], [YES]			
[ADD TO PLAYLIST] ¹	[ALL SCENES (THIS DATE)], [ONE SCENE], [CANCEL]	●	–	55
[MOVE] ²	–	●	–	56
[DELETE]	Original movies: [ALL SCENES (THIS DATE)], [ONE SCENE], [CANCEL]	●	–	40
	Scenes in the playlist: [NO], [YES]	●	–	56
[SELECT DATE] ¹	–	●	–	38
[PROTECT]	–	–	●	67
[PRINT ORDER]	–	–	●	73
[TRANSFER ORDER]	–	–	●	86

¹ Option available only from the original movies index screen.

² Option available only from the playlist index screen.

 CAMERA SETUP

Menu item	Setting options			
[SELF TIMER]	[ON ON ], [OFF OFF]	●	●	46
[D.ZOOM]	[OFF OFF], [40x 40X], [200x 200X]	●	–	–
[ZOOM SPEED]	[VAR VARIABLE], [>>> SPEED 3], [>> SPEED 2], [> SPEED 1]	●	●	34
[AF MODE]	[LAF INSTANT AF], [AF NORMAL AF]	●	●	–
[FOCUS ASSIST]	[ON ON], [OFF OFF]	●	●	–
[AF AST LAMP]	[A AUTO], [OFF OFF]	–	●	64
[FOCUS PRI.]	[AiAF ON:AiAF], [ON :CENTER], [OFF OFF]	–	●	–
[IMG STAB]	[ON ON ], [OFF OFF]	●	●	–
[FRAME RATE]	[50i 50i NORMAL], [PF25 PF25]	●	–	–
[A.SL SHUTTER]	[ON ON], [OFF OFF]	●	●	–
[REVIEW]*	[OFF OFF], [2sec 2 sec], [4sec 4 sec], [6sec 6 sec], [8sec 8 sec], [10sec 10 sec]	–	●	–
[WIND SCREEN]	[A AUTO], [OFF OFF ]	●	–	–
[MIC ATT]	[ON ON ATT], [OFF OFF]	●	–	52



* Option available only when the drive mode is set to [SINGLE].

[D.ZOOM]: Determines the operation of the digital zoom. The color of the indicator indicates the zoom.

- When activated, the camcorder will switch automatically to the digital zoom when you zoom in beyond the optical zoom range.
- With the digital zoom the image is digitally processed, so the image resolution will deteriorate the more you zoom in.

[AF MODE]: Select how fast the autofocus will operate.

- With [**LAF** INSTANT AF] the autofocus adjusts quickly to a new subject. This is convenient for example when changing the focus from a near subject to a far subject in the background, or when recording fast-moving subjects.
- When the optional Wide-converter or Tele-converter is attached to the camcorder, it may partially obstruct the Instant AF sensor. Set the AF mode to [**AF** NORMAL AF].

Optical zoom	Digital zoom	
		
White	Light blue	Dark blue
Up to 12x	12x - 40x	40x - 200x



[FOCUS ASSIST]

- The focus assist function magnifies the image that appears at the center of the screen to help you focus manually (□ 47).
- Using the focus assist function will not affect the recordings. The focus assist function will be cancelled when you start recording.

[FOCUS PRI.]: When the focus priority is activated, the camcorder records a still image only after the focus has been adjusted automatically. You can also select which AF frames to use.

[**AiAF** ON:AiAF]: One or more AF frames out of the nine frames available are automatically selected and the focus is fixed on them.

[**□** ON:CENTER]: A single focusing frame appears in the center of the screen and the focus is automatically fixed on it.

[**OFF** OFF]: No AF frame will appear and the still image will be recorded immediately after you press **[PHOTO]**.

- When the recording mode is set to [**FW** FIREWORKS], focus priority is automatically set to [**OFF** OFF].

[IMG STAB]: The image stabilizer compensates for camcorder shake even at full telephoto.

- The image stabilizer is designed to compensate for a normal degree of camcorder shake.
- We recommend setting the image stabilizer to [**OFF** OFF] when using a tripod.

[FRAME RATE]: Selects the frame rate to be used when recording.

[**PF25** PF25]: 25 frames per second, progressive. Using this frame rate will give your recordings a cinematic look. When combined with the [**CINE** CINE MODE] recording program (□ 42), the cinematic look will be enhanced.

[A.SL SHUTTER]: The camcorder automatically uses slow shutter speeds to obtain brighter recordings in places with insufficient lighting.



- The setting will not change even if you set the camcorder to **[EASY]** mode.
- In **[CAM]** mode, set the flash mode to **[OFF]** (flash off).
- If a trailing afterimage appears, set the slow shutter to [**OFF** OFF].
- If **[SHAKE]** (camcorder shake warning) appears, we recommend stabilizing the camcorder, for example, by mounting it on a tripod.

[REVIEW]: Selects the time to display a still image after it has been recorded to the memory.











- If you press **[DISP.]** while reviewing a still image it will continue to be displayed indefinitely. Press **[PHOTO]** halfway to return to the normal display.

Operating mode	Shutter speed used
[CAM] mode	As low as 1/25
[CAM] mode with [PF25 PF25] frame rate	As low as 1/12
[CAM] mode	

[WIND SCREEN]: The camcorder automatically reduces the background sound of wind when recording outdoors.

- Some low-frequency sounds will be suppressed along with the sound of wind. When recording in surroundings unaffected by wind or if you want to record low-frequency sounds, we recommend setting the wind screen to [ OFF ].

MEMORY OPER.

Menu item	Setting options					
 [MEMORY INFO]	–	●	●	●	●	–
[CARD INFO]	–	●	●	●	●	–
 [MEDIA:MOVIES]	[BUILT-IN MEM], [CARD]	●	●	–	–	30
 [MEDIA:IMAGES]	[BUILT-IN MEM], [CARD]	●	●	●	–	30
[DEL.ALL MOVIES] ¹	[NO], [YES]	–	–	●	–	41
[DEL.PLAYLIST] ²	[NO], [YES]	–	–	●	–	56
[ERASE ALL  ORD]	[NO], [YES]	–	–	–	●	74
[ERASE ALL  ORD]	[NO], [YES]	–	–	–	●	87
[ERASE ALL IMAGES]	[NO], [YES]	–	–	–	●	62
[INITIALIZE]	[BUILT-IN MEM], [CARD], [CANCEL] [INITIALIZE], [COMPL.INIT.], [CANCEL]	●	●	● ¹	●	31

¹ Option available only from the original movies index screen.

² Option available only from the playlist index screen.

[MEMORY INFO]/[CARD INFO]: Displays a screen where you can verify how much of the built-in memory (**** only) or the memory card is currently in use (total recording time and total number of still images) and how much memory remains available for recording.

- Estimated figures about available movie recording time and available number of still images are approximate and based on the recording mode and still image quality/size settings currently in use.
- In the [CARD INFO] screen you can also verify the Speed Class of the memory card.



DISPLAY SETUP

Menu item	Setting options					
[BRIGHTNESS]		●	●	●	●	–
[AUDIO LEVEL]	[ON ON], [OFF OFF]	●	–	–	–	53
[TV SCREEN]	[ON ON], [OFF OFF]	●	●	–	–	–
[DATA CODE]	[DATE], [TIME], [DATE & TIME], [CAMERA DATA]	–	–	●	–	–
[MARKERS]	[OFF OFF], [LEVEL(WHT)], [LEVEL(GRY)], [GRID(WHT)], [GRID(GRY)]	●	●	–	–	–
[LANGUAGE]	[ČEŠTINA], [DEUTSCH], [ΕΛΛΗΝΙΚΑ] [ENGLISH], [ESPAÑOL], [FRANÇAIS], [ITALIANO], [MAGYAR], [MELAYU], [POLSKI], [ROMÂNĂ], [TÜRKÇE], [РУССКИЙ], [УКРАЇНСЬКА], [العربية], [فارسی], [ภาษาไทย], [简体中文], [繁體中文], [한국어], [日本語]	●	●	●	●	28
[START WEEK]	[SATURDAY], [SUNDAY], [MONDAY]	–	–	●	–	–
[DEMO MODE]	[ON ON], [OFF OFF]	●	●	–	–	–

[BRIGHTNESS]: Adjusts the brightness of the LCD screen.

- Changing the brightness of the LCD screen does not affect the brightness of your recordings or that of the playback image on a TV.

[TV SCREEN]

- When set to [**ON** ON], the camcorder's on-screen displays will appear also on the screen of a TV or monitor connected using the STV-250N Stereo Video Cable.

[DATA CODE]: Displays the date and/or time when the scene was recorded.

[CAMERA DATA]: Displays the aperture (f-stop) and shutter speed used when recording the image.

[MARKERS]: You can display a grid or a horizontal line at the center of the screen. Use the markers as a reference to make sure your subject is framed correctly (vertically and/or horizontally).



- Using the markers will not affect the recordings.

[START WEEK]: Select the day on which the week starts for the calendar display (📅 38).

[DEMO MODE]: The demonstration mode displays the camcorder's main features. It starts automatically when the camcorder is powered with the compact power adapter if you leave it turned on for more than 5 minutes.

- To cancel the demo mode once it has started, press any button or turn off the camcorder.

🔧 SYSTEM SETUP

Menu item	Setting options	📺	📷	📺	📷	📖
[BATTERY INFO]	–	●	●	●	●	–
[WL.REMOTE]	[ON ON], [OFF OFF (📺)]	●	●	●	●	–
[BEEP]	[🔊 HIGH VOLUME], [🔊 LOW VOLUME], [OFF OFF]	●	●	●	●	–
[POWER SAVE]	[ON ON], [OFF OFF]	●	●	●	●	–
[QUICK START]	[OFF OFF], [10min 10 min], [20min 20 min], [30min 30 min]	●	●	–	–	–
[AV/PHONES]	[[AV] AV], [📞 PHONES]	●	–	●	–	53
[PHONES VOL.]	🔊 	●	–	●	–	53
[SPEAKER VOL.]	🔊 	–	–	●	–	–
[IMG NUMBERS]	[📷 RESET], [📷 CONTINUOUS]	●	●	●	●	–
[IMG QUALITY]	[📷 LW SUPER FINE], [📷 LW FINE], [📷 LW NORMAL]	–	–	●	–	–
[TV TYPE]*	[4:3 NORMAL TV], [16:9 WIDE TV]	–	–	●	–	–
[COMP.OUT]*	[576i 576i], [1080i 1080i]	●	●	●	●	–
[HDMI STATUS]	–	●	●	●	●	–
[USB SETTING]	[📀 DVD BURNER], [🖨️ PC/PRINTER], [🔌 CONNECT&SET]	–	–	●	●	–
[ADD TO DISC]	[ALL SCENES], [REM.SCENES], [PLAYLIST]	–	–	●	–	80
	[ALL IMAGES], [TRANS.ORD]	–	–	–	●	
[FIRMWARE]	–	–	–	–	●	–

* Option not available when the camcorder is connected to an HDTV using the HDMI cable.

[BATTERY INFO]: Displays a screen where you can verify the battery charge (as a percentage) and the remaining recording time (📺, 📷 mode) or playback time (📺, 📷 mode).



[WL.REMOTE]: Allows the camcorder to be operated with the wireless controller.

[BEEP]: A beep will accompany some operations like turning on the camcorder, the self-timer countdown, etc.

[POWER SAVE]: In order to save power when the camcorder is powered by a battery pack, it will automatically shut off if left without any operation for 5 minutes.

- Approximately 30 seconds before the camcorder shuts off, [AUTO POWER OFF] will appear.
- In standby mode, the camcorder will shut off after the time selected for the [QUICK START] setting.

[QUICK START]: Select whether to activate the Quick Start function when you close the LCD panel in a recording mode (□ 34) and the length of time after which the camcorder will end the standby mode and shut off automatically.

[SPEAKER VOL.]: Adjust (◀▶) the volume of the playback. You can also adjust the volume using the joystick guide (□ 54).

[IMG NUMBERS]: Select the image numbering method to be used on a new memory card. Images are automatically assigned consecutive image numbers from 0101 to 9900, and stored in folders containing up to 100 images. Folders are numbered from 101 to 998.

[🔄 RESET]: Image numbers will restart from 101-0101 every time you insert a new memory card.

[🔍 CONTINUOUS]: Image numbers will continue from the number following that of the last image recorded with the camcorder.

- If the memory card you insert already contains an image with a larger number, a new image will be assigned a number one higher than that of the last image on the memory card.
- We recommend using the [🔍 CONTINUOUS] setting.

[IMG QUALITY]: Select the quality of a still image captured from a scene.

[TV TYPE]: In order to display the picture in full and in the correct aspect ratio, select the setting according to the type of television to which you will connect the camcorder.

[4:3 NORMAL TV]: TV sets with 4:3 aspect ratio.

[16:9 WIDE TV]: TV sets with 16:9 aspect ratio.

- When the TV type is set to [4:3 NORMAL TV], the picture displayed on the LCD screen will be smaller than the full display area.
- When the TV type is set to [4:3 NORMAL TV], still images cannot be captured from the playback scene (□ 67).

[COMP.OUT]: You can select the video specifications to use when connecting the camcorder to a high-definition TV using the component video connection.

[576i 576i]: To use the 576i specification (standard definition).

[1080i 1080i]: To use the full 1080i high definition specification.

[HDMI STATUS]: You can verify the specification of the video output signal from the HDMI OUT mini terminal.

[USB SETTING]: Select the connection protocol to use when connecting the camcorder to an external device using the USB cable.





[DVD BURNER]: To connect exclusively to the optional DW-100 DVD Burner.

[PC/PRINTER]: To connect to a computer, a printer or similar USB peripherals.

[CONNECT&SET]: To make the selection from a screen that appears at the time of the connection to the external device.

[FIRMWARE]: You can verify the current version of the camcorder's firmware. This menu option is usually unavailable.

DATE/TIME SETUP

Menu item	Setting options					
[T.ZONE/DST]	List of world time zones.	●	●	●	●	28
[DATE/TIME]	–	●	●	●	●	27
[DATE FORMAT]	[Y.M.D (2008.1.1 AM 12:00)], [M.D,Y (JAN. 1, 2008 12:00 AM)], [D.M.Y (1.JAN.2008 12:00 AM)]	●	●	●	●	–

[DATE FORMAT]: Select the date format to be used for most on-screen displays, and (if selected) for the date printed on photos.



Troubleshooting



If you have a problem with your camcorder, refer to this section. Sometimes what you think is a malfunction of the camcorder may have the simplest of solutions - please read the “CHECK THIS FIRST” box before going on to the more detailed problems and solutions. Consult your dealer or a Canon Service Center if the problem persists.

CHECK THIS FIRST



Power supply

Is the battery charged? Is the compact power adapter correctly connected to the camcorder? (□ 18)

Recording

Did you turn the camcorder on and set the mode dial to  or ? (□ 24). If you are recording to a memory card, is one correctly inserted into the camcorder? (□ 30)

Playback

Did you turn the camcorder on and set the mode dial to  or ? (□ 24). If you are playing back recordings from a memory card, is one correctly inserted into the camcorder? (□ 30) Does it contain any recordings?

Power source

The camcorder will not turn on or it turns off by itself.

- The battery pack is exhausted. Replace or charge the battery pack (□ 18).
- Remove the battery pack and reattach it correctly.

Cannot charge the battery pack.

- The battery pack is too hot. The charging will start once the battery pack temperature is below 40 °C.
- Charge the battery pack in temperatures between 0 °C and 40 °C.
- The battery pack is damaged. Use a different battery pack.

A noise can be heard from the compact power adapter.

- A faint sound can be heard while the compact power adapter is connected to a power outlet. This is not a malfunction.

After using the camcorder for a long time, it becomes hot.



- The camcorder may become hot after using it continuously for long periods of time; this is not a malfunction. If the camcorder becomes unusually hot or it becomes hot after using it only for a short while, it may indicate a problem with the camcorder. Consult a Canon Service Center.

The battery pack is exhausted extremely quickly even at normal temperatures.

- The battery may have reached the end of its battery life. Buy a new battery pack.

Recording



Pressing will not start recording.

- You cannot record while the camcorder is writing previous recording onto the memory (while the ACCESS indicator is on or flashing).
- The memory is full or it already contains the maximum number of scenes. Delete some recordings ( 40, 62) or initialize the memory ( 31) to free some space.

The point where was pressed does not match the beginning/end of the recording.

- There is a slight interval between pressing  and the actual start of recording. This is not a malfunction.



The camcorder will not focus.

- Autofocus does not work on the subject. Focus manually ( 47).
- Lens or Instant AF sensor is dirty. Clean the lens or sensor with a soft lens-cleaning cloth ( 112). Never use tissue paper to clean the lens.



When a subject flits across in front of the lens, the image appears slightly bent.

- This is a phenomenon typical of CMOS image sensors. When a subject crosses very quickly in front of the camcorder, the image may seem slightly warped. This is not a malfunction.





Changing the operating mode between recording () / record pause () / playback () takes longer than usual.

- When the memory contains a large number of scenes, some operations may take longer than usual. Back up your recordings ( 80) and initialize the memory ( 31).

Reviewing the last scene recorded takes longer than usual.

- When the memory contains a large number of scenes, some operations may take longer than usual. Back up your recordings ( 80) and initialize the memory ( 31).

Cannot record a still image.

- In  mode: You cannot record a still image if simultaneous recording (FUNC. menu) is set to [STILL I. REC OFF] ( 65), or if either the digital zoom ( 90) or a digital effect ( 50) is activated.

Playback



Cannot add scenes to the playlist.

- You cannot add more than 999 scenes to the playlist.
- You may not be able to add scenes to the playlist if they were recorded or edited using another device.

Cannot delete a scene.

- You may not be able to delete scenes recorded or edited using another device.

Deleting scenes takes longer than usual.

- When the memory contains a large number of scenes, some operations may take longer than usual. Back up your recordings ( 80) and initialize the memory ( 31).

Cannot erase a still image.

- The still image is protected. Remove the protection ( 67).

Indicators and Onscreen Displays

lights up in red.

- Battery pack is exhausted. Replace or charge the battery pack ( 18).

appears on the screen.

- The camcorder cannot communicate with the battery pack attached so the remaining battery time cannot be displayed.

lights up in red.

- A memory card error occurred. Turn off the camcorder. Remove and reinsert the memory card. Initialize the memory card ( 31) if the display does not change back to normal.
- The memory card is full. Replace the memory card or delete some recordings to free some space on the memory card.

flashes in red on the screen.

- The camcorder has malfunctioned. Consult a Canon Service Center.

The CHG (charge) indicator flashes rapidly.

-  (one flash at 0.5-second intervals)
Charging has stopped because the compact power adapter or the battery pack is faulty. Consult a Canon Service Center.

The CHG (charge) indicator flashes very slowly.

-  (one flash at 2-second intervals)
The battery pack is too hot. The charging will start once the battery pack temperature is below 40 °C.
- Charge the battery pack in temperatures between 0 °C and 40 °C.
- The battery pack is damaged. Use a different battery pack.

The CHG (charge) indicator does not turn on even though a battery pack is attached.

- The camcorder cannot communicate with the battery pack attached. Such battery packs cannot be charged using this camcorder.

Picture and Sound

Screen displays turn on and off repeatedly.

- The battery pack is exhausted. Replace or charge the battery pack ( 18).
- Remove the battery pack and reattach it correctly.

Abnormal characters appear on the screen and the camcorder does not operate properly.

- Disconnect the power source and reconnect it after a short time. If the problem still persists, disconnect the power source and press the RESET button with a pointed item. Pressing the RESET button resets all settings.

Video noise appears on screen.

- When using the camcorder close to devices that emit strong electromagnetic fields (plasma TVs, cellular phones, etc.), keep a distance between the camcorder and these devices.

Horizontal bands appear on the screen.

- This is a phenomenon typical of CMOS image sensors when recording under some types of fluorescent, mercury or sodium lamps. To reduce the symptoms set the camcorder to **EASY** mode. This is not a malfunction.

Sound is distorted or is recorded at lower levels.

- When recording near loud sounds (such as fireworks, shows or concerts), sound may become distorted or it may not be recorded at the actual levels. Activate the microphone attenuator or adjust the audio recording level manually (□ 52).

The picture is displayed correctly but there is no sound from the built-in speaker.

- Speaker volume is turned off. Adjust the volume (□ 38).
- If the STV-250N Stereo Video Cable is connected to the camcorder, disconnect it.

A rattling can be heard from the camcorder.

- The internal lens fixture can move when the camcorder is turned off. This is not a malfunction.

Memory Card and Accessories

Cannot insert the memory card.

- The memory card was not facing the correct direction. Turn the memory card over and insert it (□ 30).

Cannot record on the memory card.

- The memory card is full. Erase some recordings to free some space or replace the memory card.
- Initialize the memory card (□ 31) when you use it with the camcorder for the first time.
- The LOCK switch on an SD or SDHC memory card is set to prevent accidental erasure. Change the position of the LOCK switch (□ 111).
- The folder and file numbers have reached their maximum value. Set [IMG NUMBERS] to [RESET] (□ 95) and insert a new memory card.
- The still image simultaneous recording setting in the FUNC. menu is set to [STILL I.REC OFF]. Change the setting to take photos while recording video (□ 65).
- Still images cannot be captured from the playback scene when [TV TYPE] is set to [NORMAL TV]. In such case,  appears. Set [TV TYPE] to [WIDE TV] (□ 95).

The wireless controller will not work.

- Set [WL.REMOTE] to [ON].
- Replace the battery of the wireless controller.

Connections with External Devices

Video noise appears on the TV screen.

- When using the camcorder in a room where a TV is located, keep a distance between the compact power adapter and the power or antenna cables of the TV.

Playback looks fine on the camcorder but there is no image on the TV screen.

- The video input on the TV is not set to the video terminal to which you connected the camcorder. Select the correct video input.

There is no sound from the TV.

- When connecting the camcorder to an HDTV using the CTC-100/S Component Cable, make sure to connect also the audio connections using the white and red plugs of the STV-250N Stereo Video Cable.



The camcorder is connected using the optional HTC-100 HDMI Cable, but there is no picture or sound from the HDTV.

- Disconnect the HTC-100 HDMI Cable and then restore the connection or turn the camcorder off and then on again.

The computer doesn't recognize the camcorder even though the camcorder is connected correctly.

- [USB SETTING] is set to [DVD BURNER]. Set it to [PC/PRINTER] or to [CONNECT&SET] (□ 94).
- Disconnect the USB cable and turn off the camcorder. After a short while, turn it on again and restore the connection.

The printer is not working even though the camcorder and printer are connected correctly.

- [USB SETTING] is set to [DVD BURNER]. Set it to [PC/PRINTER] or to [CONNECT&SET] (□ 94).
- Disconnect the USB cable. Turn the printer off and then on again and restore the connection.

The camcorder doesn't recognize the DW-100 DVD Burner even though it is connected correctly.

- [USB SETTING] is set to [PC/PRINTER]. Set it to [DVD BURNER] or to [CONNECT&SET] (□ 94).

List of Messages (in alphabetical order)

Following the list of messages for the camcorder you can find separate lists for print-related messages (□ 106) and for messages that appear only when using the optional DW-100 DVD Burner (□ 105).

ACCESSING THE CARD DO NOT REMOVE THE CARD

- You opened the memory card slot cover while the camcorder was accessing the memory card or the camcorder started accessing the memory card as you opened the memory card slot cover. Do not remove the memory card until this message disappears.

BACK UP RECORDINGS REGULARLY

- This message may appear when you turn on the camcorder. In the event of a malfunction, recordings may be lost so back up your recordings regularly.

BUFFER OVERFLOW RECORDING WAS STOPPED

- The data transfer rate was too high for the memory card in use and the recording was stopped. Replace the memory card with one rated Speed Class 2 or higher.

HF10 BUILT-IN MEMORY ERROR

- The built-in memory could not be read.

HF10 BUILT-IN MEMORY FULL

- The built-in memory is full ("END" appears on the screen). Delete some recordings (□ 40, 62) to free some space.

HF10 CANNOT ACCESS THE BUILT-IN MEMORY

- There is a problem with the built-in memory.

CANNOT COMMUNICATE WITH THE BATTERY PACK CONTINUE USING THIS BATTERY PACK?

- You attached a battery pack that is not recommended by Canon for use with this camcorder.

HF10 CANNOT COPY

- The total size of the scenes you selected to copy exceeds the available space on the memory card. Delete some recordings on the memory card (□ 40, 62) or reduce the number of scenes to copy (□ 57).

CANNOT EDIT

- Cannot move or delete original scenes or scenes in the playlist of the selected memory.

CANNOT EDIT CHECK THE CARD

- The memory card in the camcorder was initialized using a computer. Initialize the memory card with this camcorder (□ 31).

CANNOT ENTER THE STANDBY MODE NOW

- The camcorder cannot enter the standby mode if the remaining battery charge is too low.

CANNOT PLAY BACK

- There is a problem with the memory.

HF10 CANNOT PLAY BACK CANNOT ACCESS THE BUILT-IN MEMORY

- There is a problem with the built-in memory.

CANNOT PLAY BACK CHECK THE CARD

- There is a problem with the memory card.

HF10 CANNOT PLAY THE MOVIES IN THE BUILT-IN MEMORY INITIALIZE USING ONLY THE CAMCORDER

- The camcorder's built-in memory was initialized using a computer. Initialize the built-in memory with this camcorder (□ 31).

CANNOT PLAY THE MOVIES ON THIS CARD

- Movies cannot be played back from a 64 MB or smaller memory card.

CANNOT PLAY THE MOVIES ON THIS CARD INITIALIZE USING ONLY THE CAMCORDER

- The memory card in the camcorder was initialized using a computer. Initialize the memory card with this camcorder (□ 31).

CANNOT RECORD

- There is a problem with the memory.

HF10 CANNOT RECORD MOVIES IN THE BUILT-IN MEMORY

- The camcorder's built-in memory was initialized using a computer. Initialize the built-in memory with this camcorder (□ 31).

CANNOT RECORD MOVIES ON THIS CARD

- Movies cannot be recorded on a 64 MB or smaller memory card.

CANNOT RECORD MOVIES ON THIS CARD INITIALIZE USING ONLY THE CAMCORDER

- The memory card in the camcorder was initialized using a computer. Initialize the memory card with this camcorder (□ 31).

CANNOT RECORD ON THIS CARD USING FXP MODE

- Movies cannot be recorded in FXP mode on a memory card if it is rated Speed Class 2. Select a different recording mode (□ 33) or replace the memory card with one rated Speed Class 4 or higher.

HF10 CANNOT RECORD CANNOT ACCESS THE BUILT-IN MEMORY

- There is a problem with the built-in memory.



CANNOT RECORD CHECK THE CARD

- There is a problem with the memory card.

CARD FULL

- The memory card is full. Erase some recordings to free some space or replace the memory card.

CARD REACHED THE MAXIMUM NUMBER OF SCENES

- The memory card already contains the maximum number of scenes; no further scenes can be copied onto the memory card. Delete some recordings (□ 40, 62) to free some space.

CARD UNABLE TO RECOGNIZE THE DATA

- The memory card contains scenes recorded in a different television system (NTSC).

CHANGE THE BATTERY PACK

- Battery pack is exhausted. Replace or charge the battery pack (□ 18).

CHECK THE CARD

- Cannot access the memory card. Check the memory card and make sure it is inserted correctly (□ 30).
- A memory card error occurred. The camcorder cannot record or display the image.
- If after the message disappears, □ appears in red, perform the following: Turn off the camcorder and remove and reinsert the memory card. If □ turns back to green you can resume recording/playback.
- Initialize the memory card (□ 31). (Doing so will erase all the still images on the memory card.)

CONNECT THE COMPACT POWER ADAPTER

- When the camcorder is in  mode and is connected to the computer, this message will appear if the camcorder is being powered by the battery pack. Connect the compact power adapter to the camcorder.

COULD NOT ADD TO PLAYLIST

- Scene could not be added to the playlist (□ 55). You cannot add more than 999 scenes to the playlist. Delete some recordings (□ 40, 62).

DATA INCLUDES FXP SCENES CANNOT COPY TO THIS CARD

- Movies recorded in FXP mode cannot be copied onto a memory card if it is rated Speed Class 2. Replace the memory card with one rated Speed Class 4 or higher.

ERROR WRITING THE CARD DATA MAY BE RECOVERED IF CARD WAS NOT REMOVED RECOVER FILES?

- If power supply was accidentally interrupted while the camcorder was writing to the memory card, this message will appear the next time you turn on the camcorder. Select [YES] to try to recover the recordings. If you removed the memory card and used it with another device after this happened, we recommend you select [NO].

INITIALIZE USING ONLY THE CAMCORDER

- There is a problem with the file system that prevents accessing the selected memory. Initialize the built-in memory ( only) or memory card with this camcorder (□ 31).

MAY NOT BE POSSIBLE TO RECORD MOVIES ON THIS CARD

- You may not be able to record movies on a memory card without a Speed Class rating. Replace the memory card with one rated Speed Class 2 or higher.

NAMING ERROR

- The folder and file numbers have reached their maximum value. Set [IMG NUMBERS] to [RESET] (□ 95) and erase all the images on the memory card or initialize it.

NEED TO RECOVER FILES FROM THE CARD. CHANGE THE POSITION OF THE CARD'S LOCK SWITCH.

- This message will appear the next time you turn on the camcorder if power supply was accidentally interrupted while the camcorder was writing to the memory card and later the position of the card's LOCK switch was changed to prevent erasure. Change the position of the LOCK switch (🔒 111).

NO CARD

- There is no memory card in the camcorder.

NO IMAGES

- There are no still images to play back.

NO SCENES

- There are no scenes recorded in the memory selected.

NOT AVAILABLE IN EASY MODE

- You pressed a button that cannot be used in EASY mode (while the EASY button's blue light is on). Press the EASY button to set the camcorder to flexible recording mode.

PROCESS CANCELED

- The process was canceled following user intervention.

REACHED THE MAXIMUM NUMBER OF SCENES

- The maximum number of scenes has been reached. Delete some recordings (🗑️ 40, 62) to free some space.

HF10 READING THE BUILT-IN MEMORY

- Reading data from the built-in memory.

READING THE CARD

- Reading data from the memory card.

SOME SCENES COULD NOT BE DELETED

- Movies that were protected/edited with other devices cannot be deleted.

TASK IN PROGRESS DO NOT DISCONNECT THE POWER SOURCE

- The camcorder is updating the memory. Do not disconnect the compact power adapter or remove the battery pack.

THE CAMCORDER IS SET TO STILL IMAGE MODE

- You pressed **START/STOP** while recording still images (📷 mode).

THE CARD IS SET FOR ERASURE PREVENTION

- The LOCK switch on an SD or SDHC memory card is set to prevent accidental erasure. Change the position of the LOCK switch (🔒 111).

THE MEMORY CARD COVER IS OPEN

- After inserting a memory card, close the memory card slot cover by pulling it down until it clicks (🔒 30).

TOO MANY STILL IMAGES DISCONNECT USB CABLE

- Disconnect the USB cable and decrease the number of still images on the memory card to fewer than 1,800. If a dialog appeared on the computer screen, close it and then reconnect the USB cable.

TRANSFER ORDER ERROR

- You attempted to set more than 998 transfer orders. Reduce the number of still images marked with transfer orders.



UNABLE TO RECOGNIZE THE DATA

- You transferred data to the camcorder recorded in a different television system (NTSC).

UNABLE TO RECOVER DATA

- Could not recover a corrupted file.

WHILE THE CAMCORDER IS CONNECTED TO A PC DO NOT DISCONNECT THE USB CABLE OR POWER SOURCE CANNOT TURN OFF POWER OR CHANGE MODES

- When the camcorder is in  mode and is connected to the computer with a USB cable, the camcorder cannot be operated. Disconnecting the USB cable or power source while this message appears may result in permanent loss of the recordings in the camcorder. Use the computer's Safely Remove Hardware function to end the connection and disconnect the USB cable before using the camcorder.

Messages Related to the Optional DW-100 DVD Burner

If an error message appears while the camcorder is connected to the optional DW-100 DVD Burner, refer to the following section and also to the instruction manual of the DVD Burner.

CLOSE THE MEMORY CARD SLOT COVER

- The memory card slot cover is open. Close the cover after correctly inserting the memory card ( 30).

CONNECT THE COMPACT POWER ADAPTER

- The camcorder is being powered by the battery pack. Connect the compact power adapter to the camcorder.

DISC ACCESS FAILURE CHECK THE DISC

- There was an error when reading the disc or attempting to write onto it.
- This message can appear also if condensation has formed. Wait until the DVD burner dries completely before resuming use.
- The disc may not be loaded correctly. Try removing the disc and reinserting it.

ERROR READING THE DATA

- Error while reading the recordings from the camcorder.
- Check that the USB cable was not accidentally disconnected.

LOADING THE DISC

- Reading data from the disc.

NO DISC

- Insert a disc into the DVD Burner.
- This message can appear also if condensation has formed. Wait until the DVD burner dries completely before resuming use.

NO IMAGES

- There are no still images to add to the disc.

NO SCENES

- There are no movies to add to the disc.

NO SCENES LEFT TO ADD

- You selected to create a DVD with the [REM.SCENES] setting, but all the scenes have already been added to discs created in the past; there are no applicable scenes.

NO TRANSFER ORDERS

- You selected to create a DVD with the [TRANS.ORD] setting, but no still images have been marked with transfer orders (□ 86).

OPERATION CANCELED

- The USB cable was disconnected and the operation was canceled. Check the USB connection.

PLEASE USE ONLY THE RECOMMENDED DISCS

- Cannot record on the disc you inserted into the DVD Burner. Refer to the instruction manual of the DVD Burner.

UNABLE TO RECOVER DATA

- Could not recover a corrupted file.

Direct Print Related Messages

CANNOT PRINT!

- You attempted to print an image that was recorded with another camcorder, has a different compression, or was edited on a computer.



CANNOT TRIM

- You attempted to trim an image that was recorded with another camcorder.

CHECK PRINT SETTINGS

- Current print settings cannot be used for printing with the   button.

COMMUNICATION ERROR

- The printer is experiencing a data transfer error. Cancel printing, disconnect the USB cable and turn off the printer. After a while, turn the printer back on and reconnect the USB cable. When you are printing using the   button, check the print settings.
Or, you attempted to print from a memory card that contains a large number of images. Reduce the number of images.

COULD NOT PRINT X IMAGES

- You attempted to use the print order settings to print X images that were recorded with another camcorder, with a different compression or were edited on a computer.

FILE ERROR

- You attempted to print an image that was recorded with another camcorder, has a different compression, or was edited on a computer.

HARDWARE ERROR

- Cancel printing. Turn off the printer and turn it back on. Check the printer status. If the printer is equipped with a battery, it might be exhausted. In such case, turn off the printer, replace the battery and turn it back on.

INCOMPATIBLE PAPER SIZE

- The paper settings of the camcorder conflict with the printer's settings.

INK ABSORBER FULL

- Select [CONTINUE] to resume printing. Consult a Canon Service Center (refer to the list included with the printer) to replace the ink absorber.

INK ERROR

- There is a problem with the ink. Replace the ink cartridge.

**LOW INK LEVEL**

- The ink cartridge needs to be replaced soon. Select [CONTINUE] to restart printing.

NO INK

- The ink cartridge is not inserted or is out of ink.

NO PAPER

- Paper is not correctly inserted or there is no paper.

NO PRINTHEAD

- No print head is installed in the printer or the print head is defective.

PAPER ERROR

- There is a problem with the paper. The paper is not correctly loaded or the paper size is wrong. Alternatively, if the paper output tray is closed, open it to print.

PAPER JAM

- The paper jammed during printing. Select [STOP] to cancel printing. After removing the paper, set some paper again and retry printing.

PAPER LEVER ERROR

- Paper lever error occurred. Adjust the paper selection lever to the proper position.

PRINT ERROR

- Cancel printing, disconnect the USB cable and turn off the printer. After a while, turn the printer back on and reconnect the USB cable. Check the printer status.
- When you are printing using the  button, check the print settings.

 PRINT ORDER ERROR

- You attempted to set more than 998 still images in the print order.

PRINTER COVER OPEN

- Close the printer cover securely.

PRINTER ERROR

- A malfunction has occurred that may require repairs. (Canon inkjet printers: the printer's green power lamp and orange error lamp flash alternately.)
- Disconnect the USB cable and turn off the printer. Unplug the printer's power cord from the power outlet and contact the appropriate customer support center or service center.

PRINTER IN USE

- The printer is in use. Check the printer status.

READJUST TRIMMING

- You changed the [PAPER] settings after applying the trimming settings.

SET  PRINT ORDER

- No still image has been marked with a print order.

 NOTES

About Canon Inkjet/SELPHY DS Printers: If the printer's error indicator flashes or an error message appears on the printer's operation panel, refer to the printer's instruction manual.

- If you cannot solve the problem even after consulting this list and the printer's instruction manual, contact the closest Canon Service Center (refer to the list included with the printer).

Handling Precautions

Camcorder

Be sure to observe the following precautions to ensure maximum performance.

- **Back up your recordings periodically.** Make sure to transfer your recordings to an external device such as a computer or digital video recorder (DV 80) and back them up on a regular basis. This will protect your important recordings in case of damage and create more free space on the memory. Canon shall not be liable for any data loss.
- Do not carry the camcorder by the LCD panel. Be careful when closing the LCD panel.
- Do not leave the camcorder in places subject to high temperatures (like the inside of a car under direct sunlight), or high humidity.
- Do not use the camcorder near strong electromagnetic fields such as above TVs, near plasma TVs or mobile phones.
- Do not point the lens at strong light sources. Do not leave the camcorder pointed at a bright subject.
- Do not use or store the camcorder in dusty or sandy places. The camcorder is not waterproof – avoid also water, mud or salt. If any of the above should get into the camcorder it may damage the camcorder and/or the lens.

- Be careful of heat generated by lighting equipment.
- Do not disassemble the camcorder. If the camcorder does not function properly, consult qualified service personnel.
- Handle the camcorder with care. Do not subject the camcorder to shocks or vibration as this may cause damage.
- When mounting the camcorder on a tripod, make sure that the tripod's fastening screw is shorter than 5.5 mm and that its camera-positioning pin is retractable (not fixed). Using other tripods may damage the camcorder.

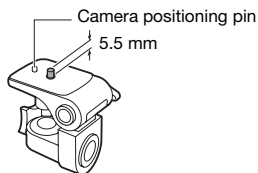

- **When recording movies, try to get a calm, stable picture.** Excessive camcorder movement while shooting and extensive use of fast zooms and panning can result in jittery scenes. In extreme cases, the playback of such scenes may result in visually induced motion sickness. If you experience such a reaction, immediately stop the playback and take a rest break as necessary.

Long-term storage

If you do not intend to use the camcorder for a long time, store it in a place free of dust, in low humidity, and at temperatures not higher than 30 °C.

Battery Pack

DANGER!



Treat the battery pack with care.

- Keep it away from fire (or it might explode).
 - Do not expose the battery pack to temperature higher than 60 °C. Do not leave it near a heater or inside a car in hot weather.
 - Do not try to disassemble or modify it.
 - Do not drop it or subject it to shocks.
 - Do not get it wet.
-
- Attach the terminal cover whenever a battery pack is not in use. Contact with metallic objects may cause a short circuit and damage the battery pack.
 - Dirty terminals may cause a poor contact between the battery pack and the camcorder. Wipe the terminals with a soft cloth.

Long-term storage

- Store battery packs in a dry place at temperatures no higher than 30 °C.
- To extend the battery life of the battery pack, discharge it completely before storing it.
- Charge and discharge all your battery packs fully at least once a year.

Regarding the use of non-Canon battery packs

- For your safety, battery packs that are not genuine Canon battery packs will not be charged even if you attach them to this camcorder or to the optional CG-800E Battery Charger.
- We recommend using genuine Canon battery packs bearing the  Intelligent Li-Ion Battery mark.
- If you attach to the camcorder battery packs that are not genuine Canon battery packs,  will appear and the remaining battery time will not be displayed.

Memory Card

- We recommend backing up the recordings on the memory card onto your computer. Data may be corrupted or lost due to memory card defects or exposure to static electricity. Canon makes no warranties for corrupted or lost data.
- Do not touch or expose the terminals to dust or dirt.
- Do not use memory cards in places subject to strong magnetic fields.
- Do not leave memory cards in places subject to high humidity and high temperature.
- Do not disassemble, bend, drop, or subject memory cards to shocks and do not expose them to water.
- Check the direction before inserting the memory card. Forcing a memory card into the slot if it is not correctly



oriented may damage the memory card or the camcorder.

- Do not attach any labels or stickers on the memory card.
- SD/SDHC memory cards have a physical switch to prevent writing on the card so as to avoid the accidental erasure of the card's content. To write-protect the memory card set the switch to the LOCK position.

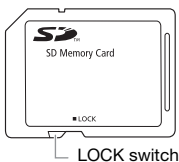

Built-in Rechargeable Lithium Battery

The camcorder has a built-in rechargeable lithium battery to keep the date/time and other settings. The built-in lithium battery is recharged while you use the camcorder; however, it will become totally discharged if you do not use the camcorder for about 3 months.

To recharge the built-in lithium battery:

Connect the compact power adapter to the camcorder and leave it connected for 24 hours with the camcorder off.

Lithium Button Battery

WARNING!

- The battery used in this device may present a fire or chemical burn hazard if mishandled.
 - Do not disassemble, modify, immerse in water, heat above 100 °C or incinerate the battery.
 - Replace with a CR2025 battery made by Panasonic, Hitachi Maxell, Sony, Sanyo, or with Duracell2025. Use of other batteries may present a risk of fire or explosion.
 - Do not insert the battery into the mouth. If swallowed, seek medical assistance immediately. The battery case may break and the battery fluids may cause internal damage.
 - Keep the battery out of the reach of children.
 - Do not recharge, short-circuit or insert the battery in the wrong direction.
 - The used battery should be returned to the supplier for safe disposal.
-
- Do not pick up the battery using tweezers or other metal tools, as this will cause a short circuit.
 - Wipe the battery with a clean dry cloth to ensure proper contact.

Disposal

When you delete movies or initialize the built-in memory (**HFTO** only) or memory card, only the file allocation table is altered and stored data is not physically erased. Take the necessary precautions when you dispose of the camcorder or memory card, for example by physically damaging it to prevent the leakage of private data.

HFTO If giving the camcorder to another person, initialize the built-in memory using the [COMPL.INIT.] setting (□ 31). Fill it up with unimportant recordings, and then initialize it again using the same method. This makes recovering the original recordings very difficult.

Maintenance/Others

Cleaning

Camcorder Body

- Use a soft, dry cloth to clean the camcorder body. Never use chemically treated cloths or volatile solvents such as paint thinner.

Lens and Instant AF Sensor

If the lens surface or Instant AF sensor is dirty, the autofocus may not work properly.

- Remove any dust or dirt particles using a non-aerosol type blower brush.
- Use a clean, soft lens-cleaning cloth to gently wipe the lens. Never use tissue paper.

LCD Screen

- Clean the LCD screen using a clean, soft lens-cleaning cloth.
- Condensation may form on the surface of the screen when the temperature changes suddenly. Wipe it with a soft dry cloth.



Condensation

Moving the camcorder rapidly between hot and cold temperatures may cause condensation (water droplets) to form on its internal surfaces. Stop using the camcorder if condensation is detected. Continued use may damage the camcorder.

Condensation may form in the following cases:

- When the camcorder is moved quickly from cold to warm places
- When the camcorder is left in a humid room
- When a cold room is heated rapidly

TO AVOID CONDENSATION

- Do not expose the camcorder to sudden or extreme changes in temperature.
- Place the camcorder in an airtight plastic bag and let it adjust to temperature changes slowly before removing it from the bag.

WHEN CONDENSATION IS DETECTED

The camcorder automatically shuts off. The precise time required for water droplets to evaporate will vary depending on the location and weather conditions. As a general rule, wait for 2 hours before resuming use of the camcorder.

Using the Camcorder Abroad

Power Sources

You can use the compact power adapter to operate the camcorder and to charge battery packs in any country with power supply between 100 and 240 V AC, 50/60 Hz. Consult a Canon Service Center for information on plug adapters for overseas use.

Playback on a TV Screen

You can only play back your recordings on TVs compatible with the PAL system. The PAL system is used in the following countries/areas:

Algeria, Australia, Austria, Bangladesh, Belgium, Brunei, China, Croatia, Czech Republic, Denmark, Finland, Germany, Hong Kong Special Administrative Region, Iceland, India, Indonesia, Iran, Iraq, Ireland, Israel, Italy, Jordan, Kenya, Kuwait, Liberia, Malaysia, Malta, Montenegro, Mozambique, the Netherlands, New Zealand, North Korea, Norway, Oman, Pakistan, Poland, Portugal, Qatar, Romania, Serbia, Sierra Leone, Singapore, Slovakia, Slovenia, South Africa, Spain, Sri Lanka, Swaziland, Sweden, Switzerland, Tanzania, Thailand, Turkey, Uganda, Ukraine, United Arab Emirates, United Kingdom, Yemen, Zambia.

System Diagram (Availability differs from area to area)

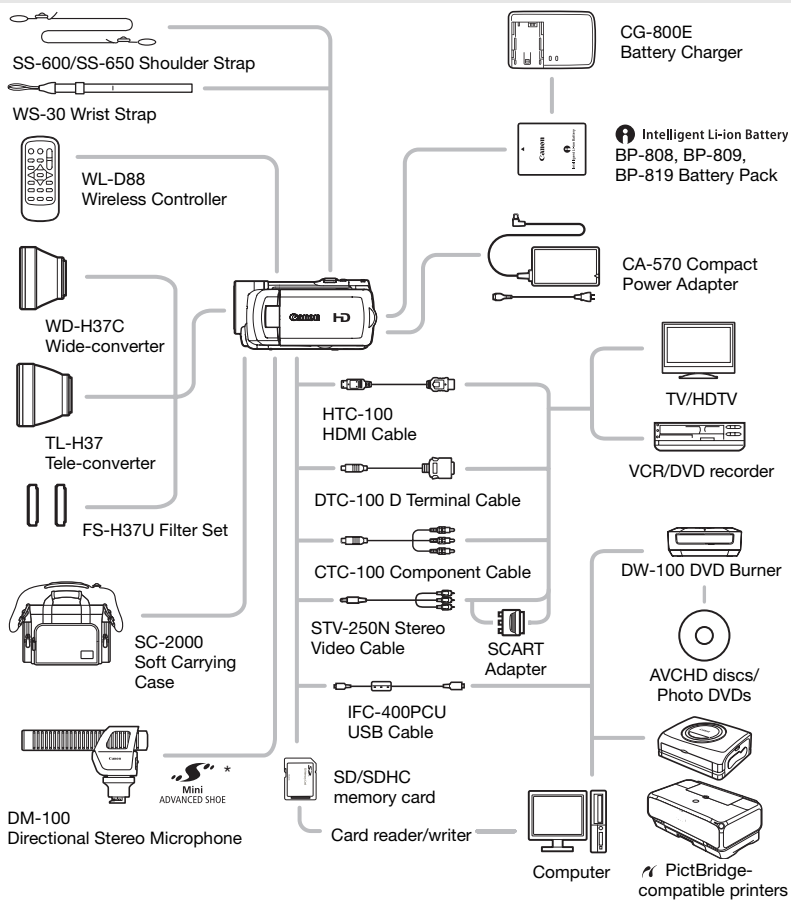

* Accessories that are compatible with the Advanced Accessory Shoe cannot be attached to this camcorder. Look for the  logo to ensure compatibility with the mini advanced shoe.



Optional Accessories

Use of genuine Canon accessories is recommended.

This product is designed to achieve excellent performance when used with genuine Canon accessories. Canon shall not be liable for any damage to this product and/or accidents such as fire, etc., caused by the malfunction of non-genuine Canon accessories (e.g., a leakage and/or explosion of a battery pack). Please note that this warranty does not apply to repairs arising out of the malfunction of non-genuine Canon accessories, although you may request such repairs on a chargeable basis.

Battery Packs

When you need extra battery packs, select one of the following models: BP-808, BP-809 or BP-819.

 Intelligent Li-ion Battery

When you use battery packs bearing the Intelligent System mark, the camcorder will communicate with the battery and display the remaining usage time (accurate to 1 minute). You can only use and charge these battery packs with camcorders and chargers compatible with Intelligent System.

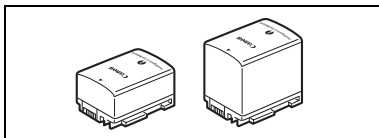

CG-800E Battery Charger

Use the battery charger to charge the battery packs.

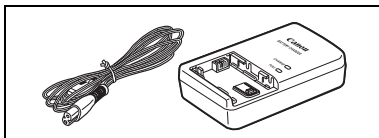

Charging Times

The charging times given in the following table are approximate and vary according to charging conditions and initial charge of the battery pack.

Battery pack →	BP-808	BP-809	BP-819
Charging conditions ↓			
Using the camcorder	155 min.	155 min.	275 min.
Using the CG-800E Battery Charger	105 min.	105 min.	190 min.

Recording and Playback Times

The recording and playback times given in the following table are approximate and vary according to recording mode and charging, recording or playback conditions. The effective usage time of the battery pack may decrease when recording in cold surroundings, when using the brighter screen settings, etc.

Using a memory card

Battery pack	Recording mode→	FXP	XP+	SP	LP
	Usage time↓				
BP-808 BP-809	Maximum recording time	80 min.	90 min.	90 min.	90 min.
	Typical recording time*	50 min.	55 min.	55 min.	55 min.
	Playback time	110 min.	115 min.	115 min.	115 min.
BP-819	Maximum recording time	165 min.	180 min.	180 min.	180 min.
	Typical recording time*	105 min.	110 min.	110 min.	110 min.
	Playback time	225 min.	230 min.	235 min.	235 min.

HFO Using the internal memory

Battery pack	Recording mode→	FXP	XP+	SP	LP
	Usage time↓				
BP-808 BP-809	Maximum recording time	80 min.	90 min.	90 min.	90 min.
	Typical recording time*	50 min.	55 min.	55 min.	55 min.
	Playback time	115 min.	120 min.	120 min.	120 min.
BP-819	Maximum recording time	170 min.	180 min.	185 min.	185 min.
	Typical recording time*	105 min.	115 min.	115 min.	115 min.
	Playback time	235 min.	240 min.	245 min.	245 min.

* Approximate times for recording with repeated operations such as start/stop, zooming, and power on/off.

TL-H37 Tele-converter

This Tele-converter lens increases the focal length of the camcorder lens by a factor of 1.5.

- The image stabilizer is not as effective when the Tele-converter is attached.
- The minimum focusing distance at full telephoto with the TL-H37 is 3 m.
- When the Tele-converter is attached, a shadow may appear in the picture when you record with flash or mini video light.

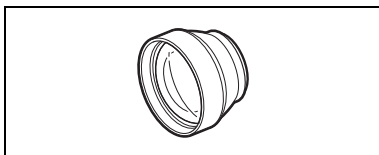



WD-H37C Wide-converter

This lens decreases focal length by a factor of 0.7, giving you a wide perspective for indoor shots or panoramic views.

- When the Wide-converter is attached, a shadow may appear in the picture when you record with flash or mini video light.
- When taking photos with a 4:3 aspect ratio with the Wide-converter attached, depending on the position of the zoom, the Wide-converter's frame may appear in the picture.

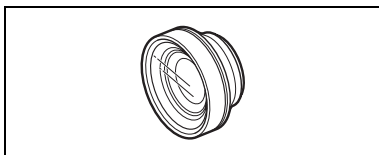

FS-H37U Filter Set

Neutral density and MC protector filters help you to control difficult lighting conditions.

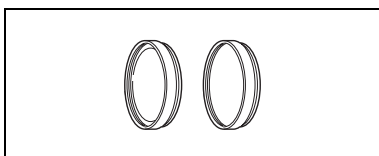

HTC-100 HDMI Cable

Use this cable to connect the camcorder to an external device using an all-digital connection, allowing you to enjoy playback at the highest quality. This cable sends both video and audio signals.

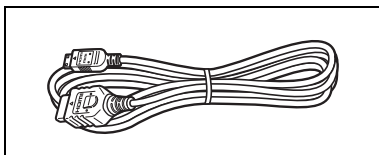

DM-100 Directional Stereo Microphone

This highly sensitive, super-directional microphone attaches to the camcorder's mini advanced shoe. It can be used as directional microphone (monaural) or stereo microphone.

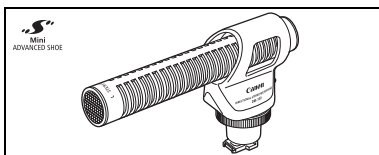

Shoulder Strap

You can attach a shoulder strap for more security and portability.

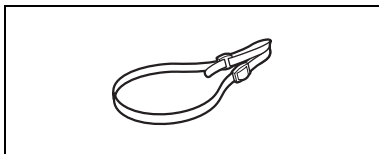

SC-2000 Soft Carrying Case

A handy camcorder bag with padded compartments and plenty of space for accessories.



This mark identifies genuine Canon video accessories. When you use Canon video equipment, we recommend Canon-brand accessories or products bearing the same mark.





Specifications

HF10/HF100

System	
Recording System	Movies: AVCHD Video compression: MPEG-4 AVC/H.264, Audio compression: Dolby Digital 2ch Still images: DCF (Design rule for camera system), compatible with Exif ¹ Ver. 2.2 and with DPOF Still image compression: JPEG (Super Fine, Fine, Normal)
Size of Video Recordings	FXP mode: 1920 x 1080 pixels Other recording modes: 1440 x 1080 pixels
Size of Still Images	 mode: 2048 x 1536, 1920 x 1080, 1440 x 1080, 640 x 480 pixels Simultaneous recording: 1920 x 1080, 848 x 480 pixels
Television System	1080/50i ²
Recording Media	HF10 Built-in flash memory, 16 GB; SD or SDHC (SD High Capacity) memory card (not included) HF100 SD or SDHC (SD High Capacity) memory card (not included)
Maximum Recording Time (approximate figures)	HF10 Built-in memory: FXP mode: 2 hr. 5 min. XP+ mode: 2 hr. 50 min. SP mode: 4 hr. 45 min. LP mode: 6 hr. 5 min. 4 GB memory card: FXP mode: 30 min. XP+ mode: 40 min. SP mode: 1 hr. 10 min. LP mode: 1 hr. 30 min.
Image Sensor	1/3.2-inch CMOS, approx. 3,310,000 pixels Effective pixels: Movies: approx. 2,070,000 Still images (LW): approx. 2,070,000 Still images (L, M, S): approx. 2,760,000
LCD Screen	2.7 in., wide, TFT color, approx. 211,000 pixels
Microphone	Stereo electret condenser microphone
Lens	f=4.8-57.6 mm, F/1.8-3.0, 12x optical zoom 35 mm equivalent: Movies: 42.9-514.8 mm Still images (LW): 42.9-514.8 mm Still images (L, M, S): 39.3-471.6 mm
Lens Configuration	11 elements in 9 groups (2 aspheric elements)
Filter Diameter	37 mm
AF System	Autofocus (TTL + external distance sensor when set to [INSTANT AF]); Manual focus available
Minimum Focusing Distance	1 m; 1 cm at full wide angle
White Balance	Auto white balance, custom white balance and preset white balance settings: DAYLIGHT, SHADE, CLOUDY, TUNGSTEN, FLUORESCENT, FLUORESCENT H
Minimum Illumination	0.2 lx ([NIGHT] recording program, Shutter speed at 1/2) 2.5 lx ([PROGRAM AE], Auto slow shutter [ON], Shutter speed at 1/25)
Recommended Illumination	More than 100 lx
Image Stabilization	Optical-Shift Image Stabilizer

¹ This camcorder supports Exif 2.2 (also called "Exif Print"). Exif Print is a standard for enhancing the communication between camcorders and printers. By connecting to an Exif Print-compliant printer, the camcorder's image data at the time of shooting is used and optimized, yielding extremely high quality prints.

² Recordings made with the [PF25] frame rate are converted and recorded on the memory as 50i.

Terminals

AV OUT/⌚ Terminal	<p>∅ 3.5 mm minijack; Output only (dual purpose terminal also for headphones stereo output)</p> <p>Video: 1 Vp-p / 75 ohms unbalanced</p> <p>Audio: -10 dBV (47 kohm load) / 3 kohm or less</p>
USB Terminal	mini-B, USB 2.0 (Hi-Speed USB)
COMPONENT OUT Terminal (Proprietary mini-D terminal)	<p>Luminance (Y): 1 Vp-p / 75 ohms</p> <p>Chrominance (P_B/P_R (C_B/C_R)): ±350 mVp-p</p> <p>1080i (D3) / 576i (D1) compatible</p>
HDMI OUT Terminal	HDMI mini, type C connector (19 pins); Output only
MIC Terminal	<p>∅ 3.5 mm stereo minijack</p> <p>-57 dBV (with 600 ohm microphone) / 5 kohms or more</p>

Power/Others

Power supply (rated)	7.4 V DC (battery pack), 8.4 V DC (compact power adapter)
Power consumption (SP mode, AF on)	3.9 W (LCD screen, normal brightness, recording in the built-in memory*) * HF10 only
	4.0 W (LCD screen, normal brightness, recording on a memory card)
Operating temperature	0 - 40 °C
Dimensions (W x H x D)	73 x 64 x 129 mm excluding the grip belt
Weight (camcorder body only)	380 g

CA-570 Compact Power Adapter

Power supply	100 - 240 V AC, 50/60 Hz
Rated output / consumption	8.4 V DC, 1.5 A / 29 VA (100 V) - 39 VA (240 V)
Operating temperature	0 - 40 °C
Dimensions	52 x 29 x 90 mm
Weight	135 g



BP-809 Battery Pack

Battery type	Rechargeable lithium ion battery, compatible with Intelligent System
Rated voltage	7.4 V DC
Operating temperature	0 – 40 °C
Battery capacity	890 mAh
Dimensions	30.7 x 27.5 x 40.2 mm
Weight	47 g

Weight and dimensions are approximate. Errors and omissions excepted. Subject to change without notice.

Index

25F progressive frame rate 17, 91
 25p Cinema Mode 42

A

Abroad, using the camcorder 113
 AEB - Auto exposure bracketing 64
 AF-assist lamp 64
 Aperture (f number) 43
 Aspect ratio of a connected TV
 (TV type) 95
 Audio recording level 52
 Auto slow shutter 90
 Autofocus (AF)
 AF frame
 (9-point AiAF/Center point) 91
 Instant AF/Normal AF 90
 Av (recording program) 43
 AV OUT/ Ω terminal 53, 75
 AVCHD specifications 4

B

Backlight correction 46
 Battery pack
 Battery information 17
 Charging 18
 Remaining charge indicator 17
 Beach (recording program) 43
 Beep 95
 Built-in backup battery 111

C

Calendar display 38
 Cine Mode (recording program) 42
 COMPONENT OUT terminal 77
 Condensation 113
 Connections to external devices 77
 Continuous shooting 64

Copying*

Movies 57
 Still images 68

D

Data code 51, 93
 Date and time 27
 Date format 96
 Daylight saving time 28
 Time zone 28
 Deleting/Erasing
 Movies 35, 40, 56
 Still images 60, 62
 Digital effects 50
 Direct print 69
 Direct transfer 84
 Drive mode 64
 DVD authoring 80

E

EASY mode 23
 Error messages 101
 Exposure 46

F

Fireworks (recording program) 43
 Flash 63
 Focus
 Assist functions 47, 91
 Focus priority 91
 Manual 47, 91
 Frame rate 42, 91
 FUNC. menu 25, 88

H

HDMI OUT mini terminal 77, 79
 Headphones 53

* **HF10** only.



I		
Image effects	49	
Image stabilizer	91	
Index screen	36, 61	
Initializing the memory	31	
J		
Joystick	24	
Joystick guide	24	
L		
Language	28	
LCD screen	22	
Light metering mode	66	
M		
Magnifying a still image	62	
Maintenance	112	
Manual exposure adjustment	46	
Markers	93	
Memory card	110	
MIC terminal	54	
Microphone	53	
Microphone attenuator	52	
Mini advanced shoe	54	
Mini video light	45	
N		
Night (recording program)	43	
O		
Onscreen display selection	51	
Original recordings	55	
P		
P (recording program)	43	
Playback		
Movies	36	
Still images	60	
Playlist	55	
Portrait (recording program)	43	
Power save	32	
Print order	73	
Print/share button	70, 85	
Printing still images	69	
Protecting still images	67	
Q		
Quick Start function	34	
R		
Recording		
Movies	32	
Still images	58	
Recording mode	33	
Recording programs	42, 43	
Recording time	33	
Remote sensor	20	
RESET	99	
Reviewing		
Movies (Record review)	35	
Still images (Review)	91	
S		
Screen icons	15	
SD/SDHC memory card	29	
Searching scenes by date	38	
Selecting the memory*		
for playback	36, 61	
for recording	30	
Self timer	46	
Serial number	13	
Setup menus	26, 90	
Shutter speed	43	
Simultaneous recording	65	
Slideshow	61	
Snow (recording program)	43	
Special Scene		
(recording programs)	42	
Sports (recording program)	43	
Spotlight (recording program)	43	
Still image numbers	95	
Still image quality	58	

* **HF10** only.

Still image size 58
 Sunset (recording program) 43

T

Telephoto 34
 Timeline 39
 Transfer order 86
 Transferring to a computer
 Movies 80
 Still images 84
 Troubleshooting 97
 Tv (recording program) 43

U

USB terminal 75

V

Volume 38, 95

W

White balance 48
 Wide angle 34
 Wind screen 92
 Wireless controller 19

Z

Zoom 34
 Digital zoom 90
 Zoom speed 34, 90

Trademark Acknowledgements

- The SD logo is a trademark. The SDHC logo is a trademark.
- Microsoft, Windows and Windows Vista are trademarks or registered trademarks of Microsoft Corporation in the United States and/or other countries.
- Macintosh and Mac OS are trademarks of Apple Inc., registered in the U.S. and other countries.
- HDMI, the HDMI logo and High-Definition Multimedia Interface are trademarks or registered trademarks of HDMI Licensing LLC.
- "AVCHD" and the "AVCHD" logo are trademarks of Matsushita Electric Industrial Co., Ltd. and Sony Corporation.
- Manufactured under license from Dolby Laboratories.
 "Dolby" and the double-D symbol are trademarks of Dolby Laboratories.
- Other names and products not mentioned above may be trademarks or registered trademarks of their respective companies.
- This product is licensed under AT&T patents for the MPEG-4 standard and may be used for encoding MPEG-4 compliant video and/or decoding MPEG-4 compliant video that was encoded only (1) for a personal and non-commercial purpose or (2) by a video provider licensed under the AT&T patents to provide MPEG-4 compliant video. No license is granted or implied for any other use for MPEG-4 standard.





DIE-300

Canon

Canon Europa N.V.

P.O. Box 2262, 1180 EG Amstelveen, the Netherlands

Canon UK Ltd.

CCI Service Centre, Unit 130

Centennial Park, Borehamwood, Hertfordshire, WD6 3SE, England

Telephone 0870-241-2161

Canon Australia Pty. Ltd.

Info-Line: 131383

www.canon.com.au

Canon New Zealand Ltd.

Customer Care: (09) 489 0470

www.canon.co.nz

Canon Singapore Pte. Ltd

1 HarbourFront Avenue, #04-01 Keppel Bay Tower, Singapore 098632

Tel: (65) 6799 8888

Fax: (65) 6799 8882

Canon Hongkong Company Ltd

19/F, The Metropolis Tower, 10 Metropolis Drive,

Hunghom, Kowloon, Hong Kong

Canon Latin America, Inc.

Sales & Enquiries: 703 Waterford Way, Suite 400, Miami, FL 33126 USA

The information in this manual is verified as of January 2008.
